



# HIGHLIGHTS 2024

---

NEWS FROM **ELKO EP** & **iNELS** WORLD

---



**30** years  
of innovations

## iNELS Wireless wonders

Showcase the latest advancements in our wireless technologies.

---

## Matter Marvels

Unveil the magic of our Matter-compatible devices.

---

## Icons configurator

Introduce news-worthy icons configuration.

---

## iNELS Bus Breakthroughs

Highlight innovations in our bus systems, creating a connected experience.

---

## Apps and Cloud

Explore the latest from our iNELS applications and the cloud.

---

## Relay Releations

Spotlight on relays.

4



8



10



19



22



26



# Wall Touch panel with clever functions



The RF Touch-2 wall touch unit is a central element for controlling heating, switching electrical appliances and equipment, dimming lights or controlling blinds and detectors.

It includes a temperature and humidity sensor for the thermostat function. It sends and receives commands from the elements and displays everything on a four-inch capacitive display.

The room temperature can be adjusted using a digital thermoregulator and the device is also able to create cooling circuits.

RF Touch-2 allows quick control and creation of scenes that perform the required actions on the set devices. For example, it can simultaneously close blinds and dim lights in the living room.

The touch unit is fully compatible with the iNELS mobile application and can be connected to iNELS CLOUD.



# Control DALI by wireless



Ultra-small unit for controlling lights and ballasts with DALI protocol. It comes in two versions: **RFDALI-04B-SL** for 4 DALI addresses and **RFDALI-32B-SL** for 32 addresses.

Powers and automatically scans the DALI bus. Assigning addresses to groups and connecting to wireless controllers or sensors is done via WiFi. RFDALI enables the creation of scenarios with other elements for controlling classic LED lights or blinds. It is possible to add to the control from system units and aps.

## External input for button



All the lights on the bus can be controlled with one classic button.

## WiFi for easy setup



Assign lights to groups and connect to wireless switches easily via computer or phone.

## Part of a iNELS Wireless portfolio



You can connect to any wireless unit, application or cloud.

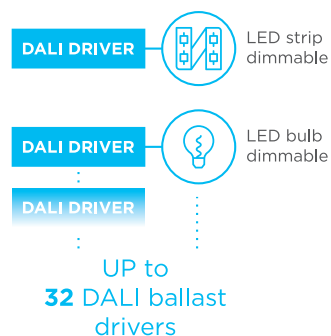

More details about **RFDALI-32B-SL**



# Glass touch controller with dimmer



Glass touch controller with integrated Dimmer allows you to dim LED or even classic lights and control them directly from the touch unit. The buttons on the touch unit can also be used to control other dimmers from the iNELS Wireless portfolio.

Lights can be added to groups and other units can be assigned to them, such as switch units for shutters, dimmable sockets, or other wireless controllers. The number of added units is practically unlimited. Up to 4 scenarios can be controlled from the Glass touch controller.



The output can be controlled by up to 25 separate buttons (external Wireless Controller).



The buttons can control an unlimited number of Wireless devices.

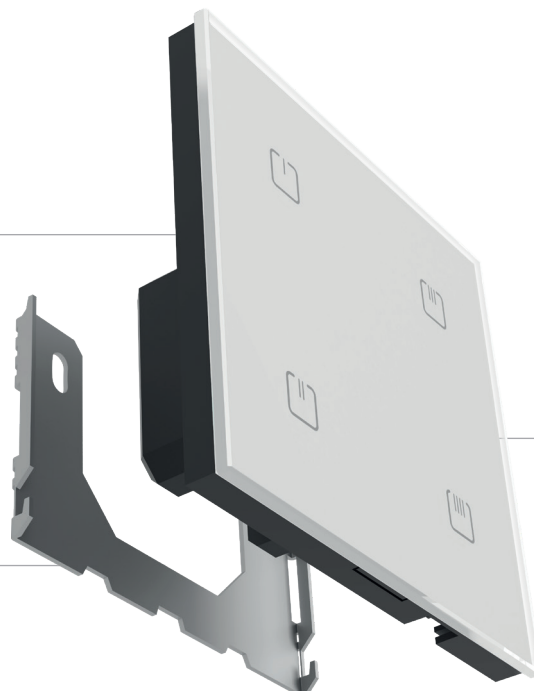

More details about **RFWD-71**

# Glass touch controller with relays



Glass touch controller with integrated relays is used to control 2 light zones or other appliances. The relays have a ZERO CROSS function, so they are capable of switching even larger LED loads.



The connection with other wireless switches or sensors is very easy, so it is possible to create staircase scenes and automation using sensors, or simply to control the built-in relays from several places at the same time.

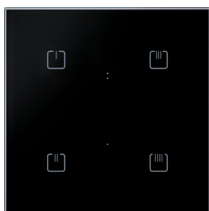

Black glass sharp edges  
RFSW-62/B



White glass sharp edges  
RFSW-62/W



Black glass round edges  
RFSW-262/B



White glass round edges  
RFSW-262/W



More details about **RFSW-62**

# It does Matter

Matter is a new standard for home automation, which connects Smart Home units with devices from manufacturers of popular technology, i.e. their applications and control systems into a single standard.

In practice, this means that a customer buys a relay or dimmer and scans it into the HomeKit application on their iPhone or the SmartThings application on their Samsung smart TV, without having to deal with complex mutual integrations.

iNELS has 6 tuned out units in its portfolio, which are primarily intended for controlling lights. They are Switch unit, Universal dimmer, Wireless switch, Glass touch controller, Window and door detector and motion detector.

These absolute novelties on the Smart Home market are quickly finding their first users, and ELKO EP, as always, guarantees that these are not toys but a professional Smart Home solution that will serve the customer well for many years.







## Our Matter products portfolio

RFMD-200/MT

Motion detector

RFGB-40B/MT

Glass touch controller  
4 buttons, black glass

RFWD-100/MT

Window/Door  
detector

RFWB-40G/MT

On-wall button controller  
4 buttons

RFDEL-71B-SL/MT

Universal dimmer  
1-channel - 1x 300 VA

RFSAI-62B-SL/MT

Switch unit with inputs  
for external buttons, zero  
crossing  
2x 8 A (total)



# Online Customization



ELKO EP as a manufacturer has technologies that allow us to offer you a wide range of customization: colors of controls, shapes of glass, icons and button descriptions, including hotel room numbers and even hotel logos. Special and unusual combinations can be made on request.

We can supply the entire order with elements pre-programmed from the factory so that you only install them according to their codes in the correct room numbers. This will significantly reduce programming and commissioning costs.



Select your favourite colour and material.



Online customization:  
[icons.inels.com](https://icons.inels.com)

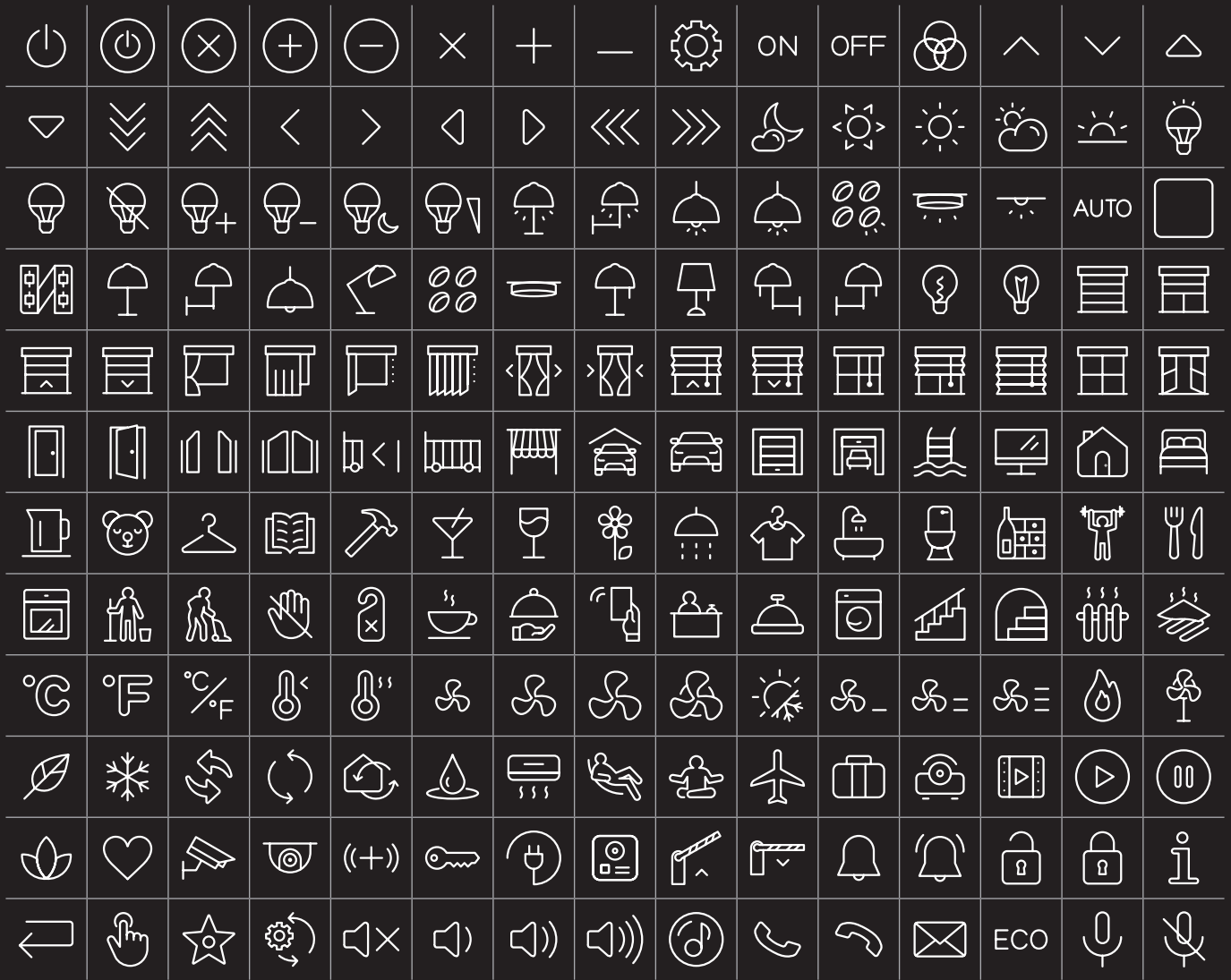

ROUND  
SHARP

custom text

custom icons

● OR ●  
black white

hotel logo

BEDSIDE LAMP	MAIN LIGHT	BEDSIDE LAMP
UP	DOWN	ON / OFF
DND	BUZZER	MUR
<b>HOTEL LOGO</b>		

variable wall background



# Your Gateway to Smart Control



Explore home automation or a professional managing large-scale projects using the **CU3-08M**, your gateway to intelligent control.

- IP/ETH RJ 45 2x iNELS BUS, up to 64 devices,
- remote control, iNELS cloud app,
- MQTT, 3<sup>rd</sup> party integration

## Home Automation



Create a smart home ecosystem where the CU3-08M serves as the brain, managing and controlling various connected devices with precision.

## Cloud Connectivity



Directly communicate with the iNELS cloud through Ethernet connector. Enjoy mobile app control and iNELS cloud feature within the IP topology.

## Commercial Projects



Scale up your projects effortlessly by integrating multiple CU3-08M units, offering centralized control for diverse applications.

## MQTT Protocol Integration



Seamlessly communicate with third-party devices through the implemented MQTT protocol, opening up possibilities for comprehensive control and automation.

## Dual BUS Connectivity



Connect up to 64 elements (2x32) effortlessly, expanding your iNELS BUS portfolio with flexibility and ease.

## IoT Integration



Leverage the power of IoT with MQTT connectivity, enabling monitoring and control, integration for an array of IoT devices.



More details about **CU3-08M**

# Transform into zero crossing



Enhance your electrical setup with the **SA3-014M** Switching Actuator, ensuring unmatched precision and control.

Transform your electrical systems with cutting-edge zero-crossing technology! Trust the SA3-014M for steadfast and dependable performance in challenging situations.

Attain precision in your electrical processes through zero-crossing synchronization. Perfect for a variety of applications, including lighting, appliances, shutters/blinds, and more.

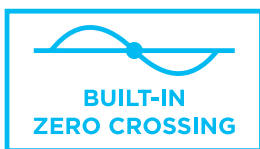

## Zero Crossing Technology



Enjoy synchronized relay operation at the zero voltage point of the sinusoidal waveform.

## 14 Independent Relays



Each with NO potentialless contacts, switching the same potential with a maximal loadability of 10A.

## Individual Control



Customize your outputs effortlessly with individual control of the fourteen contacts.



## JA3-014M Shutter Actuator

The Best option for controlling shutters and curtains.



More details about **SA3-014M**

# Touch the Future



Empower each button to command any appliance in your system. Assign unique functions or macros to create a personalized smart home environment. One button, multiple appliances - it's that simple!

## Stylish Illumination



Illuminate your space with the elegant glow of RGB LED lights on individual buttons. Create ambiance and functionality in one sleek design.

## Versatile Functionality



Embedded with an integrated temperature and Humidity Sensor. 1x analog and digital inputs to connect external devices.

## Easy Installation



Designed for mounting into a standard installation box.

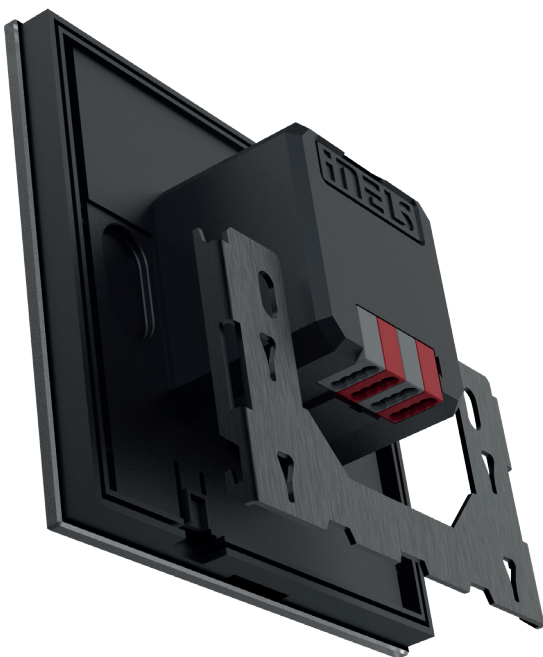

More details about **GSB3**

**4 buttons / sharp**

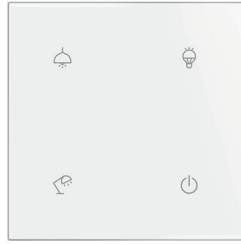

GSB3-40W

**6 & 9 buttons / sharp**



GSB3-60B

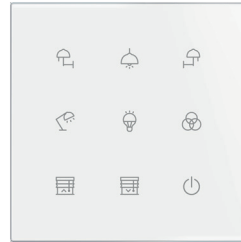

GSB3-90W

**4 buttons / rounded**



GSB3-240B



GSB3-240W

**6 buttons / rounded**



GSB3-260B

**9 buttons / rounded**

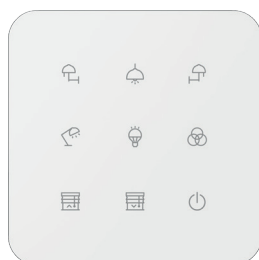

GSB3-290W



GSB3-290B

# Integral part of the control panels



Socket panels are an essential part of every hotel room's controls. They replicate the designs of the glass GSB and metal MSB controllers. Various device modules can be inserted into the frames: 110/230V multistandard socket, USB A+C, HDMI, LAN, PIR and others. You can thus create combinations to suit your wishes, whether for your bed, TV or desk.

For the design variants, the PMS multistandard socket in matt black is used. These devices are available in polar white and matt black. The hole in the GSS3/MSS3 can be filled with a 2Module accessory or 2× 1Module. A 1Module blind cover is available.

## Glass plates finishes



GSF3-PMS/B  
B - Black glass



GSF3-PMS/W  
W - White glass

## Metal plates finishes



MSF3-PMS/B  
B - Graphite black



MSF3-PMS/C  
C - Antique copper



MSF3-PMS/G  
G - Satin brass



MSF3-PMS/S  
S - Brushed silver



More details about **MSS3**



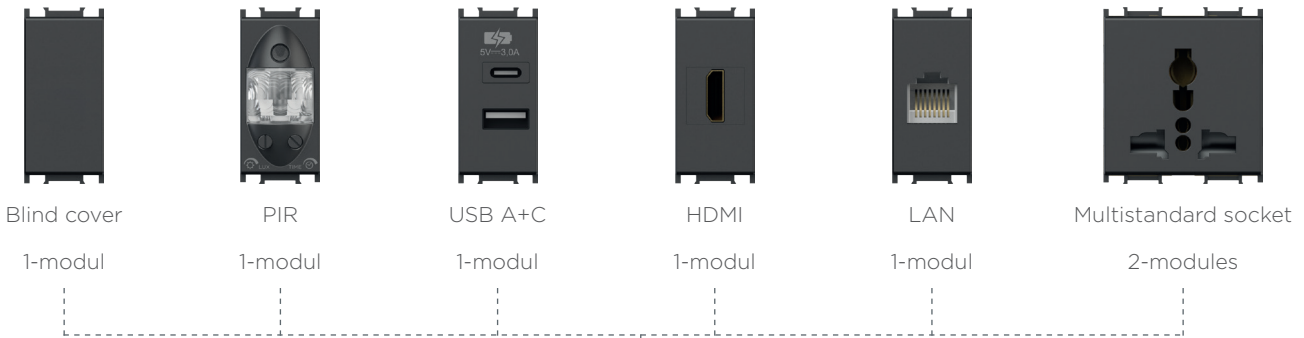
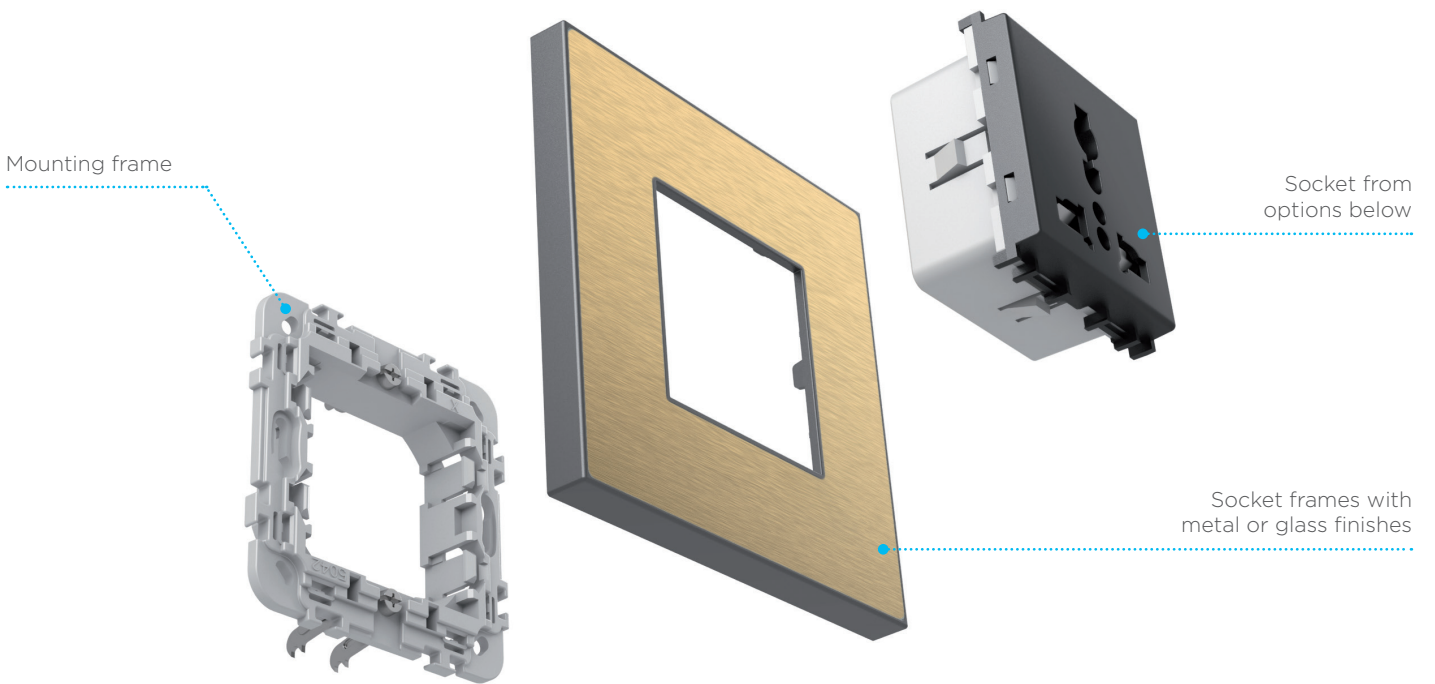

USB-A+C sockets & LAN RJ45

AC power multistandard socket PMS

Metal switch buttons with indicators

# When glass and metal come together

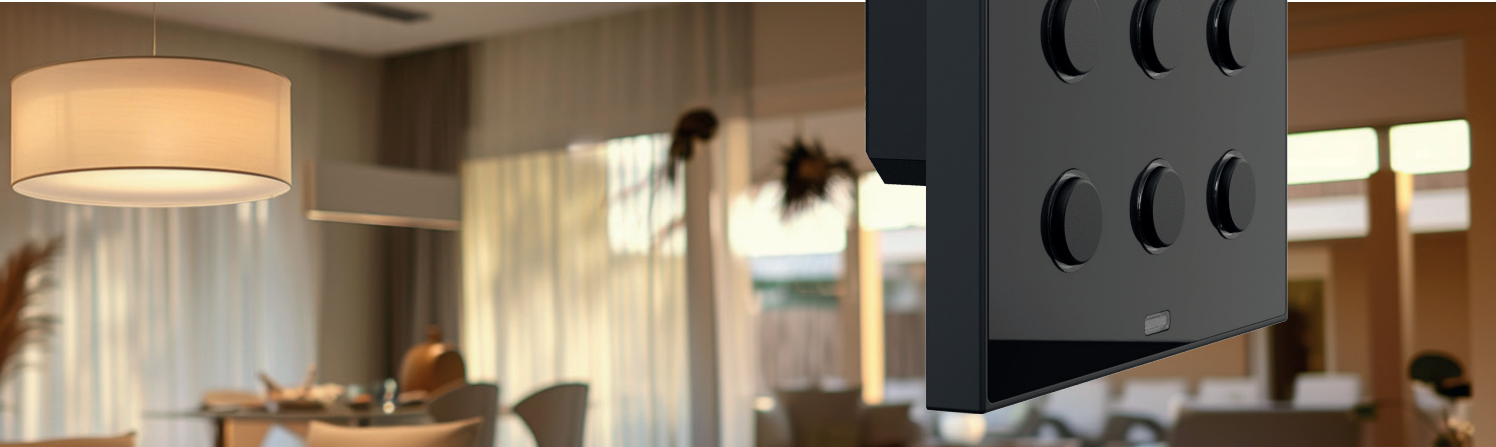
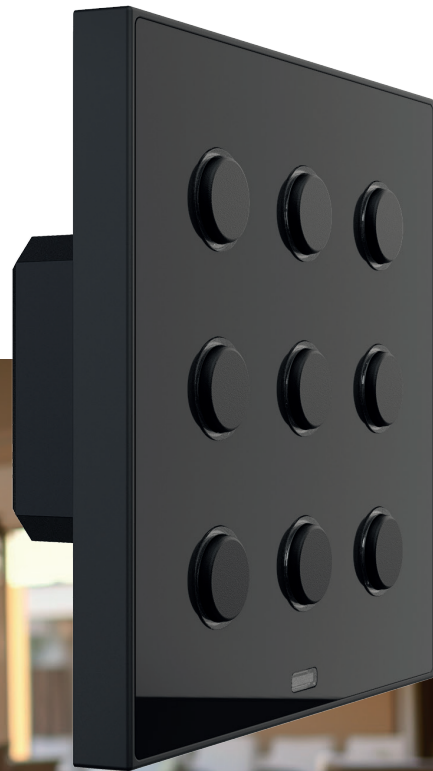

As a compromise between GSB3 (glass) and MSB3 (metal), we present the ZSB3 collection, which is set in a frame that, like MSB3, corresponds to the GSS3 sockets panels.

They are available in a black variant, black glass with graphite buttons, or a white variant, white glass and white plastic buttons. Always in a 4, 6 or 9 button configuration, with adjustable backlighting around the edge.

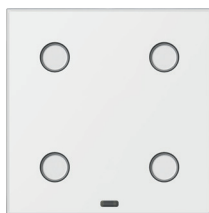

ZSB3-40/W  
White Glass

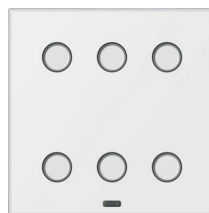

ZSB3-60/W  
White Glass

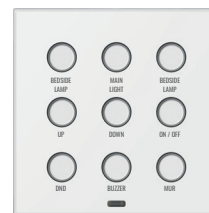

ZSB3-90/W  
White Glass



ZSB3-40/B  
Black Glass



ZSB3-60/B  
Black Glass



ZSB3-90/B  
Black Glass

Even on the glass one can freely label texts or symbols.



More details about **ZSB3**

# Luxury without compromise



The new range of metal control panels combines the luxury of metal surfaces with the elegance of a classic button press. Four finishes are available - for both panels and buttons: Brushed Silver, Satin Brass, Antique Copper or Graphite Black.

The white backlighting of the buttons, whose function and brightness can be defined by software, adds an even higher level of comfort to the chosen design. The panels can be freely customized with icons and text - see [icons.inels.com](https://icons.inels.com) configurator.



Brushed Silver  
4 buttons

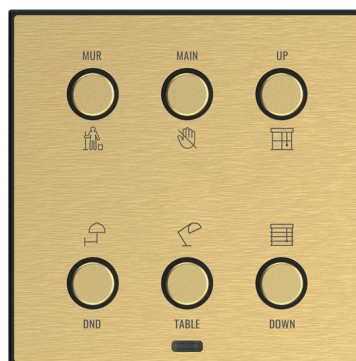

Satin Brass  
6 buttons

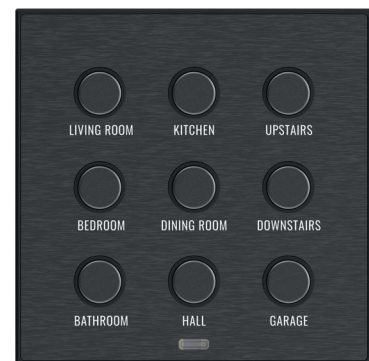

White Sharp  
9 buttons



More details about **MSB3**



Make your design: [icons.inels.com](https://icons.inels.com)



# Experience microwave technology

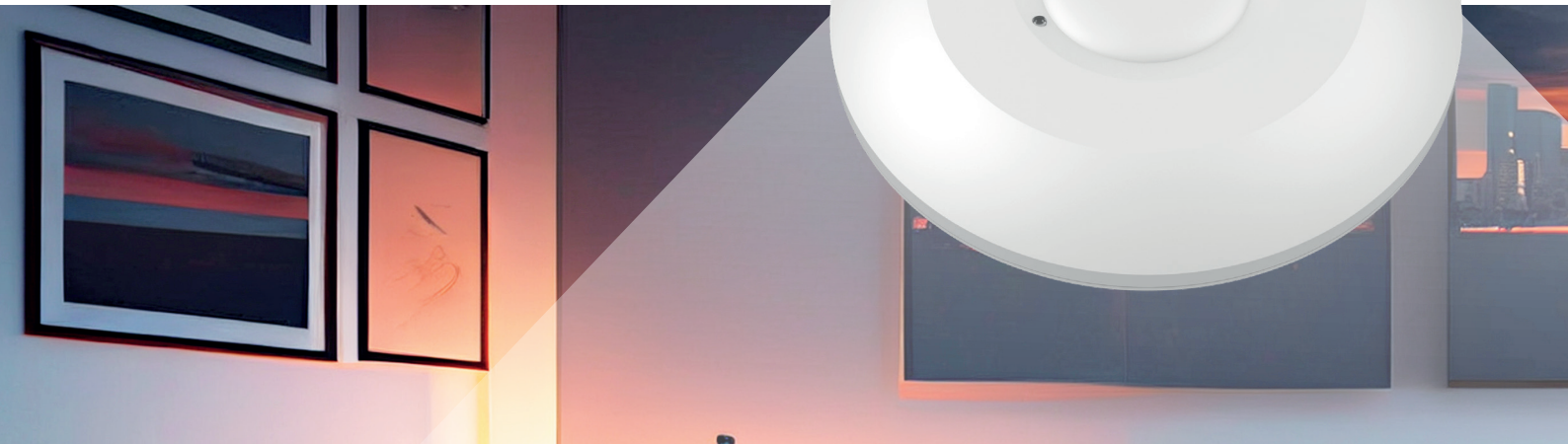

Step into the future of motion detection - Upgrade to the **MCD3-01** Ultra Slim Microwave Motion Detector. Elevate your space with cutting-edge technology, seamless integration, and unparalleled precision.

## Ultra-Slim Design



Seamlessly integrates into any environment with its compact and slim profile, offering versatile ceiling or surface mounting options.

## Adjustable Reach



Customize your detection range from 2 to 10 meters in radius, providing flexibility for various applications.

## Smart Integration



Seamlessly combine with other iNELS units using iDM3 software for enhanced automation and customized control scenarios.

## Effortless Installation



With dimensions of 115 × 24 mm, the MCD3-01 is designed for easy integration into different ceiling or surface mounting applications.

## Versatility in Applications



Ideal for a range of environments, from homes to commercial spaces, ensuring security and automation tailored to your needs.

## Microwave Technology



Experience unparalleled precision with a 5.8 GHz continuous wave radar system in the ISM band.

## 360° Detection Angle



Enjoy comprehensive coverage with a wide-angle lens, ensuring no motion escapes the MCD3-01's watchful eye.



More details about **MCD3-01**

# Experience the future of Motion Detection



Are you looking for a smart and reliable way to control the lighting in your home or office? Do you want to save energy and money while enhancing the comfort and security of your space? If so, you need the **PMS3-01**, the ultra-slim PIR motion detector from ELKO EP.

## Integration and Automation



- seamlessly integrates with iNELS units using iDM3 software
- enables automation and customization for tailored control scenarios

## Application



- ensure the safety of your home with intelligent motion detection
- enhance security and energy efficiency in offices and retail spaces
- reliable performance in challenging industrial environments
- optimal for public spaces like libraries, museums, and community centers
- improve guest experience by automating lighting and climate control

## Ultra-Slim Design



- seamlessly integrates into any environment
- aesthetically pleasing for a modern look

## 360° Detection



- comprehensive coverage for enhanced security
- precise and reliable motion detection using infrared technology

## Adjustable Time Settings



- customizable activation duration to suit specific project requirements
- enhances energy efficiency and control

## Wide Detection Range



- up to 6 meters range for versatile applications
- install at different heights (2.5m-3.5m) for flexibility



More details about **PMS3-01**

# Function preview

One of the standout features of iNELS Cloud is its ability to empower users to remotely control their wireless or BUS devices without the need for a public IP address. This eliminates the hurdles associated with accessing installations remotely, providing convenience and accessibility to users of smart homes and larger automated setups..

The outsourcing of data to the cloud not only ensures enhanced stability but also opens the doors to a broader range of third-party device integration and interconnection. This advancement promises a more enjoyable user experience, allowing seamless integration with popular voice control platforms like Google Home and Amazon Alexa, offering users greater flexibility and control.

In a move set to redefine hospitality automation, iNELS Cloud introduces the HRS (Hotel Reception Software) console.

This cutting-edge console enables real-time monitoring of room status, including occupancy, MUR/DND, and grants control over vital functions such as temperature, lighting, and welcome scenes. The HRS software can be deployed on a dedicated hotel server or accessed through a Cloud version online, providing hotels with unprecedented flexibility in implementing smart technologies.

Complementing the HRS console is a dedicated smartphone app designed for housekeeping. This app furnishes housekeeping staff with crucial information on room occupancy and cleaning requests, streamlining operations and enhancing overall efficiency.

iNELS Cloud is set to elevate the way users interact with their connected environments, bringing about a new era of smart living.



## Dashboard

Device overview with the option to view event history.

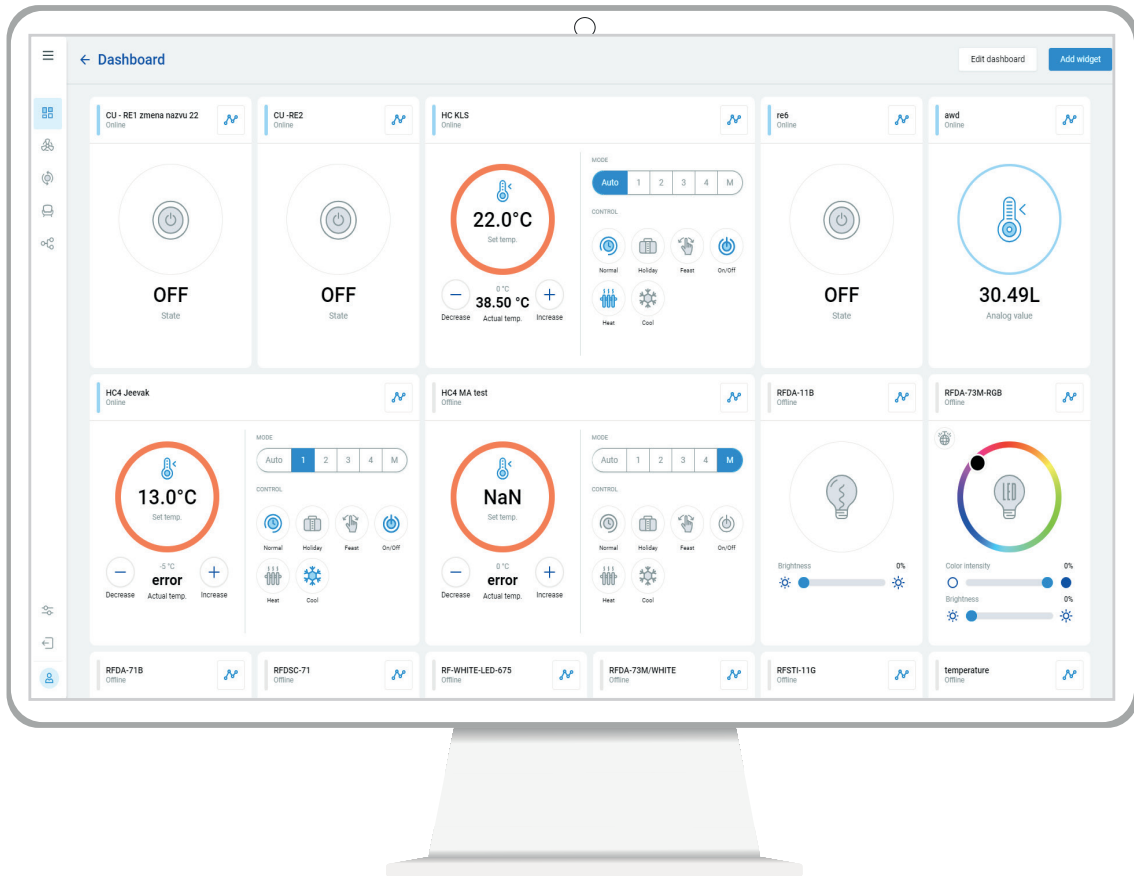

## Rooms management

Settings according to individual rooms.

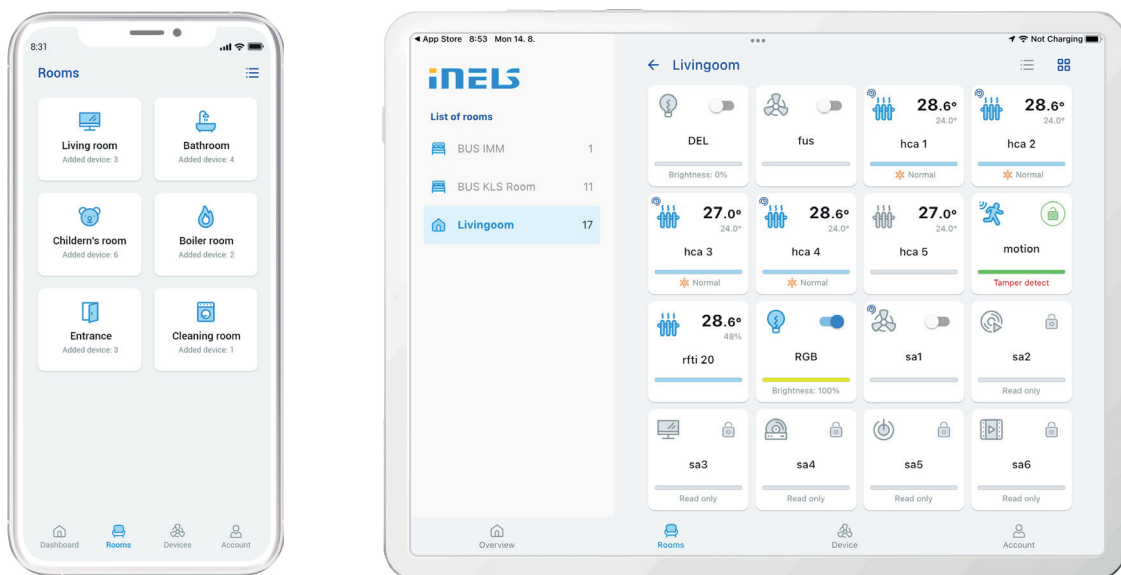

# All what you need for your SMART home, office, building...

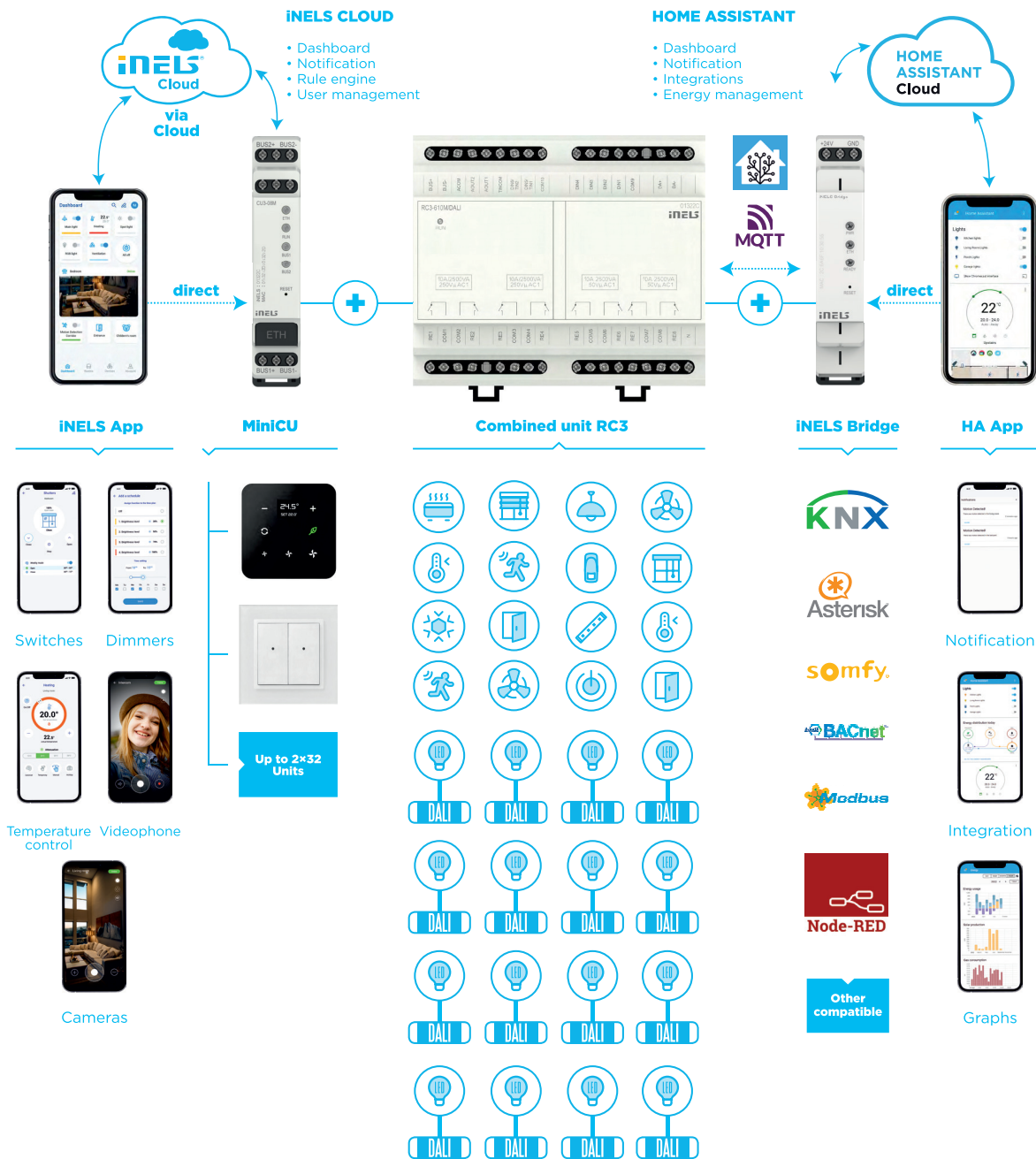



# Unlimited control options



The iNELS gateways, both in wired (CU3-08/09/10M) and wireless (eLAN-RF-103) versions, have implemented bidirectional MQTT communication. In practice, this means that real-time data from all iNELS system components are sent to the MQTT Broker (iNELS Bridge). Additionally, thanks to the bidirectional communication, these components can be freely controlled.

This approach makes the iNELS system open for easy integration into superior BMS (Building Management Systems) and PMS (Property Management Systems). It can be easily connected to third-party systems and implemented into various applications.

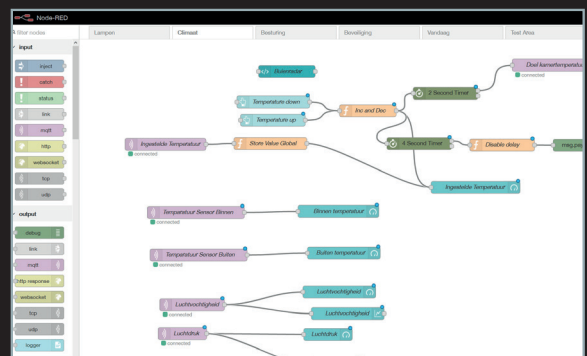
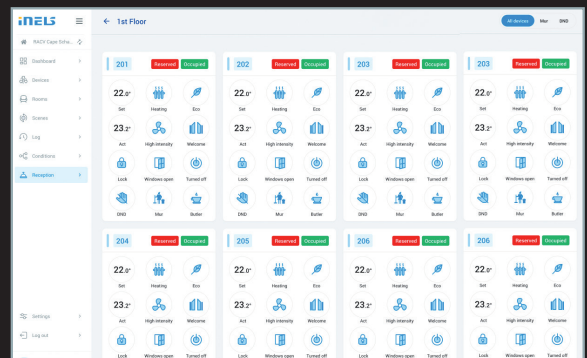
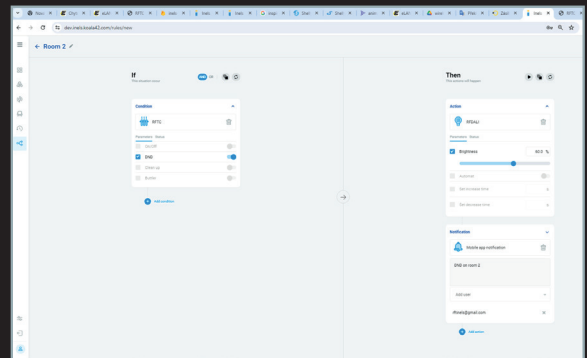

# Multifunction digital time switch with Wi-Fi



It can be used to control various electrical devices according to different programs (daily, weekly, yearly, and astronomical). It has a universal supply voltage range of AC/DC 24 - 240 V and a user-replaceable battery for backup.

It has one changeover output with a maximum current of 16 A. This product is suitable for various applications such as lighting, heating, ventilation, irrigation, pumps, and more. You can easily set up and control this product using the ELKO Smart app on your smartphone or tablet.

## Features

- NTP time synchronization
- NEW display with white backlit
- connection to network
- repeat for time programs
- PIN code, backup, astro interrupt, and more

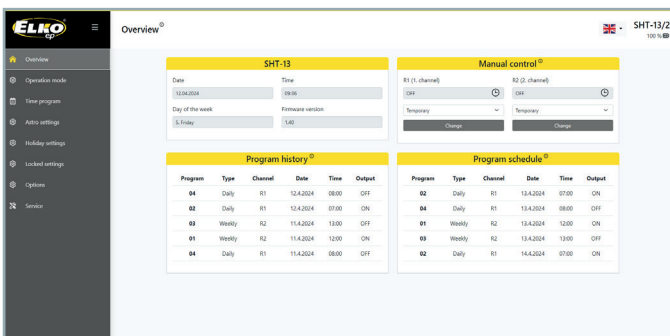

More details about **SHT-13/2**

# Multifunction monitoring voltage relay for AC/DC



It is used to monitor the value of alternating or direct voltage in 1-phase circuits. It has a supply voltage from the monitored voltage.

It monitors voltage exceeding the upper voltage level ( $U_{max}$ ) and falling below the lower voltage level ( $U_{min}$ ) - according to the selected function. It has a smooth adjustment of both voltage levels - the lower level  $U_{min}$  is set in % of the upper level  $U_{max}$ . It has an adjustable time delay (to eliminate short-term voltage drops and spikes). It has the option of choosing functions with memory of the error state (Latch).

The memory of the error state can be reset by the control input (R). It measures the true effective value of the voltage - TRUE RMS. It has one changeover output with a maximum current of 16 A.

## Features

- supply from monitored voltage
- adjustable hysteresis
- possibility of latch functions
- reset control input
- more ranges: AC/DC 24-150V, AC/DC 48-276V, DC 6-30V

1x CO  
16 A

1x CO  
16 A

AC/DC  
MON.

TRUE  
RMS

MULTI  
FUNCTION

## Example of function

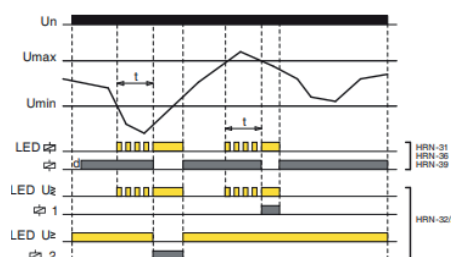

**W**  
WINDOW  
(hysteresis 5%)



More details about **HRN-31/2**

# Multifunction current monitoring relay for AC



It is used to monitor the value of alternating current in 1-phase circuits. It has a supply voltage from the monitored voltage.

It monitors current exceeding the upper level ( $I_{max}$ ) and falling below the lower level ( $I_{min}$ ) – according to the selected function. It has a smooth adjustment of both current levels – the lower level  $I_{min}$  is set in % of the upper level  $I_{max}$ . It has an adjustable time delay ( $t$ ) to eliminate short-term current spikes and drops). It has the option of choosing functions with memory of the error state (Latch). The memory of the error state can be reset by the control input (R).

It measures the true effective value of the current - TRUE RMS. It has one changeover output with a maximum current of 16 A. It has a 1-module housing and dimensions of 90 x 17.6 x 64 mm.



More details about **PRI-34**

## Features

- without galvanic isolation
- can be used with current transformer



## Example of function

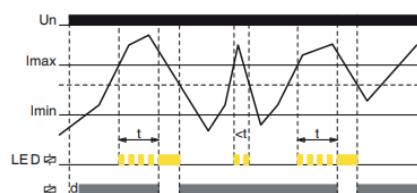

**01** OVER (hysteresis 5%)

# Multifunction time relay with supply voltage disconnection



It can be used to delay the switching off of a backup power supply and systems in case of power failure. It has four functions that can be selected by a rotary switch.

It has two changeover outputs with a maximum current of 8 A. It has a 1-module housing and dimensions of 90 x 17.6 x 64 mm. Holds contact for the set time even during power failure.

## Another variable types

- star-delta timer
- single function relays
- energy-saving time relay
- emergency light tester

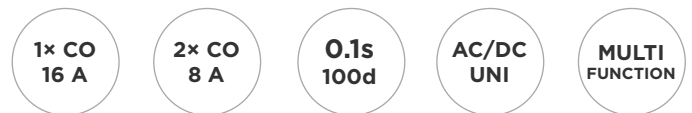

## Example of function

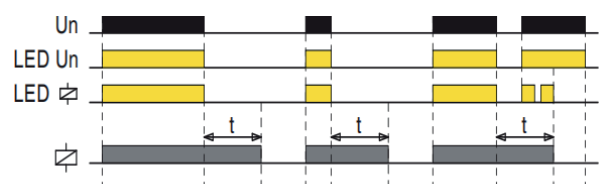

**a** True OFF Delay



More details about **CRM-72TO**

# iNELS for everything & everywhere



## Magyar State Opera

Budapest, Hungary

- every additional lighting source is also controlled by iNELS system. The devices here are controlled by RF Touch
- for switching the RFSA-11B and RFSA-66M is used.



## Sunseeker yacht

Mallorca, Spain

- data processing and weather station information
- controlling of the air temperature in the boat and outdoors (sea, etc.) entry security
- lighting control



## Moni's Jewelry

Budapest, Hungary

- jewelry shop in the heart of Budapest
- unique jewelry & Forever Mark diamonds



## Riyadh Metro

Saudi Arabia, Riyadh

- protection for tunnel ventilation fan
- in underground stations
- TER-7 - thermostat for monitoring temperature of motor winding
- 188 pieces in 12 metro stations

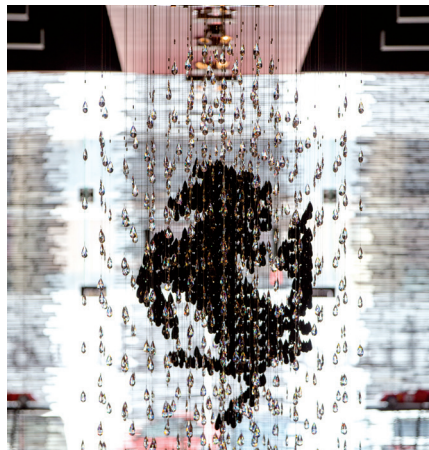

## Ferrari Showroom

Ferrari Showroom, Dubai, UAE

- lighting control in cooperation with Preciosa Lighting



## New Living Center

Prague, Czech Republic

- New Living Center is a place for architects, designers, developers, but also for every design lover
- the whole concept is conceived as a standard living space with smart control
- exhibition of design frames LOGUS<sup>90</sup>



iNELS References | [inels.com/references](https://inels.com/references)



### SPA hotel NEMO

Ukraine / Odessa

- luxury and comfort thanks to smart technology iNELS BUS
- the air conditioning, lights and the fire system in hundred hotels rooms it is the project scope
- the basic element is the control of Mitsubishi HVAC with a support of hotel thermostats GRT3 and iNELS glass touch controllers



### Mashroat Office

Saudi Arabia / Riyadh

- the headquarters of government company Mashroat Office - The National Project Management, Operation and Maintenance Organization
- The lighting control of the conference facilities and corridors divided into 8 rooms and 32 dimmable circuits



### iNELS Café

Prague, Czech Republic

- fusion of smarthome showroom
- from each table it is possible to control some features and setup the site via an iPad
- 4 tables with 32" full screen touch glass with special app
- individual 15 m<sup>2</sup> iNELS showroom



### Kuwait Society of Engineer

Kuwait, Bneid Al Qar

- KSE is one of the leading institutes in Kuwait where it holds more than 5 thousand engineers serving various government and private sectors
- iNELS has installed a combination of BUS & RF solutions to control lighting, blinds, and shutters
- KSE is one of the strategic supporters of iNELS and working together on other technological projects



### Hyundai

Nošovice, Czech Republic

- 736 pcs LED High Bay within retrofitted lighting
- central control DALI ballast via EDMC
- control of each zone from the touch panel via app



### Movenpick Hotel

JLT, United Arab Emirates

- Client: IFA Hotels and Resortd
- Contractor: Drake and Scull, Dubai, UAE
- Consultant: Al gurg Consultants, Dubai, UAE
- System: GRMS + Lighting
- Control System
- Total Floors: 40
- Total Room: 400



● **Headquarters**

ELKO EP Holding SE, Czech Republic

---

● **Europe**

ELKO EP Balkan d.o.o  
ELKO EP Bulgaria OOD  
ELKO EP Germany GmbH  
ELKO EP Hungary Kft.  
ELKO EP POLAND Sp. z o.o.  
ELKO EP SLOVAKIA, s.r.o.  
ELKO EP UK Ltd.  
ELKO EP UKRAINE LLC

● **Africa & Middle East**

ELKO EP Egypt LLC  
ELKO EP Kuwait Ltd.  
ELKO EP MEA LLC  
ELKO EP Saudi Arabia Ltd.

● **America**

ELKO EP North America LLC

---



**ELKO EP, s.r.o.** | Palackeho 493 | 769 01 Holesov, Vsetuly | Czech Republic  
phone: +420 573 514 221 | fax: +420 573 514 227 | [elko@elkoep.com](mailto:elko@elkoep.com) | [www.elkoep.com](http://www.elkoep.com)