

HRESK

wireless retrofit for existing hotel room



www.inels.com/hresk

powered by



RETROFIT FOR EXISTING HOTEL ROOM

There are approximately 17 million hotel rooms in the World, of which more than 70% are over 10 years old.

For all these rooms, which are not equipped with any system that would guarantee comfort for the guest and economic benefit for the hotel operator, HRESK is designed.

HRESK is a set of devices that control lighting, temperature and courtesy functions. The communication between these devices is done wirelessly on a radio-protocol designed for building automation. Wireless communication allows easy installation without cables, saving time, money and also building modifications.

HRESK is flexible. All features can be selected or only selected features - for example lighting control - and the rest can be added in later stages.



Wireless Installation

Our system eliminates the need for extensive cabling by seamlessly integrating thermostats and sensors.



Design

All panels are in a luxurious glass finish. They can be customized with icons, descriptions and even the hotel logo.



Enhanced Control

Guests can easily manage room settings with a master switch conveniently located bedside.



No Wifi

The RFIO2 radio protocol is used for wireless communication at sub-gigahertz. This allows for repeating between units, thus greatly improving the quality and extending the range.



Integration

Cooperation with door locks and hotel reception software is a matter of course. Information about room occupancy, service or cleaning requests is exchanged. Everything happens automatically.



Rapid Installation

With our wireless solution, installation is swift and hassle-free, promising minimal disruption to your operations.

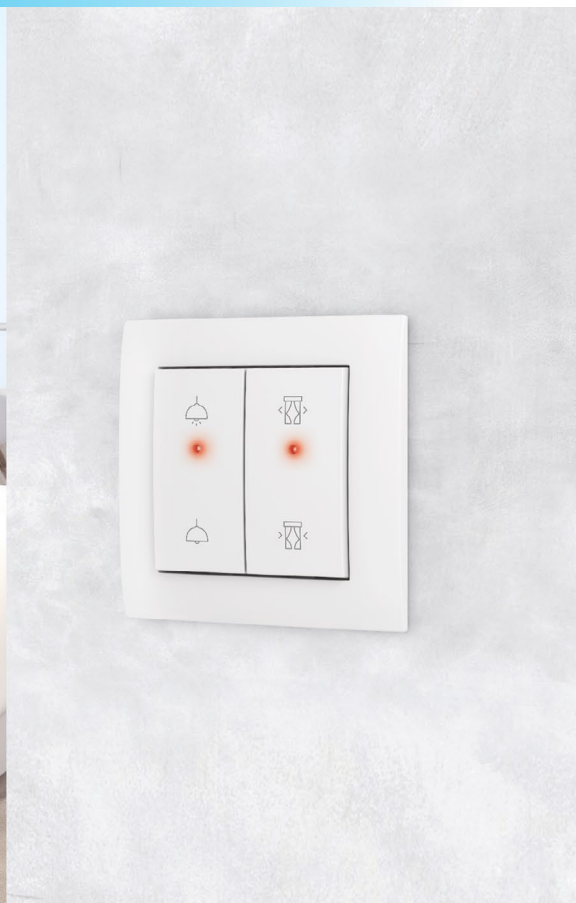
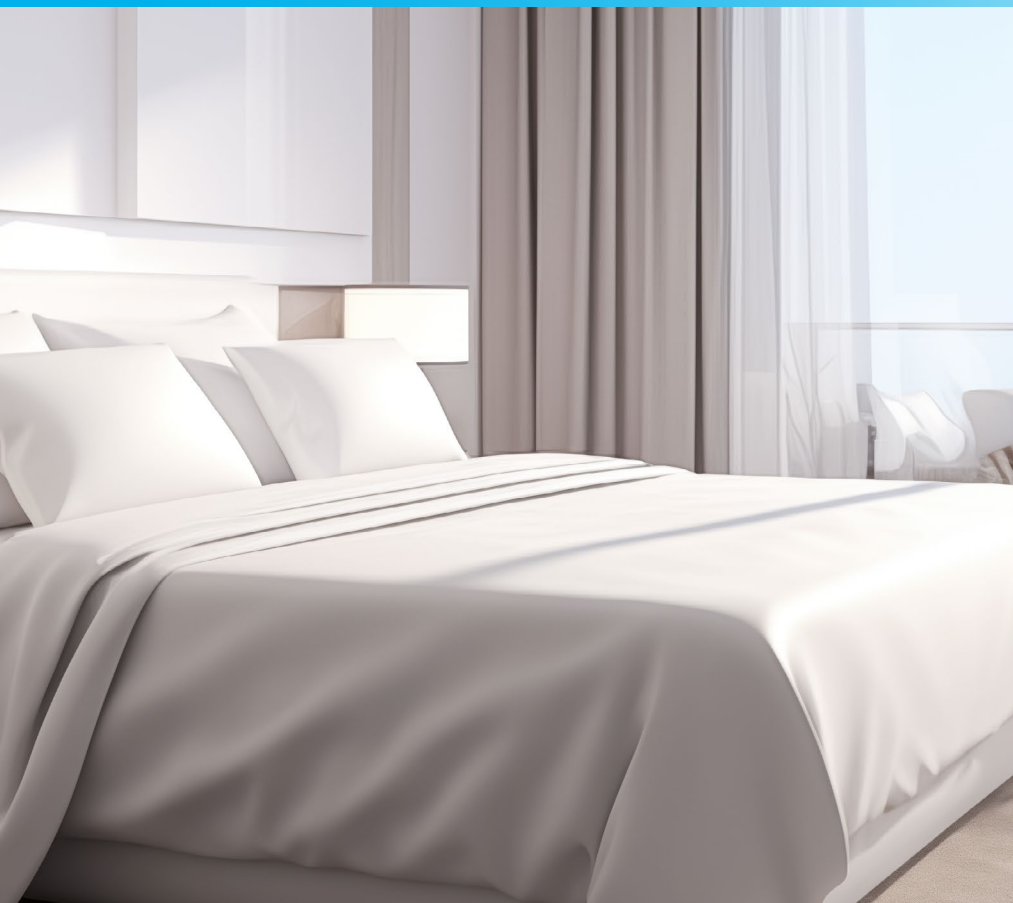

Centralized Management

Explore the possibility of central monitoring, allowing efficient management and monitoring of all room control points.



Check In/Out

Thanks to integration into a hotel system, it is possible to create a light scene in the room when a guest registers.



Apparent saving

Anticipate a minimum 25% reduction in energy consumption per room, ensuring a favorable Return on Investment (ROI).



Smart Detection

Smart devices that can allow you to automatically control lighting or activate alarms when motion is detected inside the building.



Automation

Functions happen automatically in the background without disturbing the guest. An open window sensor blocks the thermostat, a PIR detector controls lighting and temperature.



Comfort

The main goal of every hotelier is to make the guest feel comfortable. This is helped by high-quality environment regulation and intuitive control, including dimming and the play of light colors.



EXAMPLE OF USE CASE



WIFI/MQTT
to PMS/
HRS

Control	•
Lighting	•
Temperature	•
Access	•
Curtains	•
Courtesy	•
Audio	-
TV integration	•
Occupancy	•
Controllers	•
Plastic	•
Glass	•
Metall	x
Touch	•
Integration	•
PMS	•
HRS	•
iNELS App	•
Access/Lockers	•

- 1** Infront of door hotel room unit
RFBS-30/S, 24V/230V powered
- 2** Glass touch controller with symbols
RFSW-62/S, 24V/230V powered
- 3** Glass touch thermostat for fancoils
RFTC-3, 230V powered, MQTT gateway included
- 4** Motion detector for ceiling mounting
RFMD-200, battery powered
- 5** Window/door detector
RFWD-100, battery powered
- 6** Glass touch controller, 4 buttons
RFGB-40, battery powered
- 7** Switch unit, 2 channels
RFSAI-62B-SL, 230V powered
- 8** DALI controller, 4 DALI balast
RFDALI-04/B-SL, 230V powered

Look video how HRESK works





Infront of door glass communication and signalization panel



1a
Most often there is a classic bell button in front of the hotel room door.



1b
We will replace it with the RFGS-30/S information and communication panel.



1c
This way we get not only the bell button, but also the MUR/DND information and the illuminated room number.

Courtesy

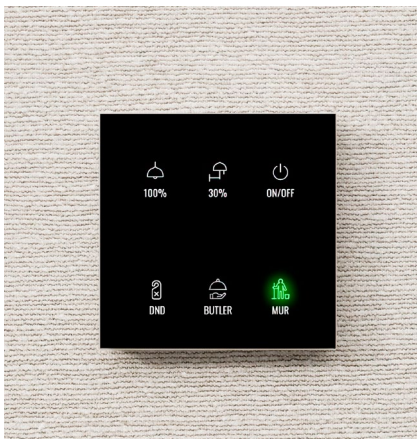

2a
On the RFSW-62S indoor control panel you can select MUR/DND (buttons are interlocked) or call Butler.

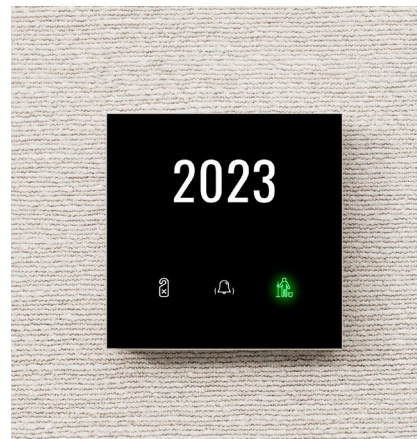

2b
Activated buttons are displayed on the in-front-of-door panel RFB-S-30S.

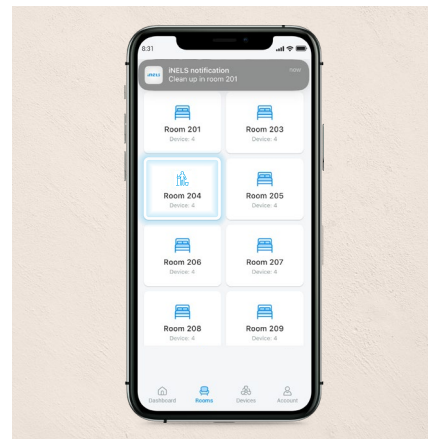

2c
And at the same time push-on to the phone app of the cleaner or services.



Fancoil thermostat



3a
An old, ugly, unintuitive and often non-functioning thermostat. You turn the dial several times to find the right temperature.

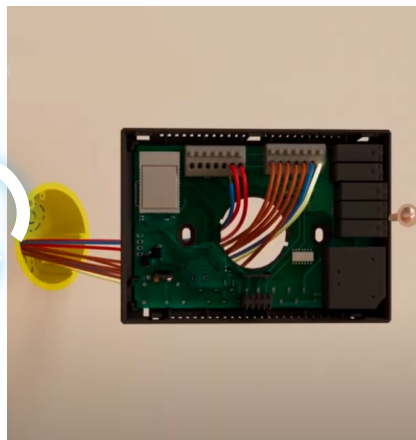

3b
Replacing this original thermostat is easy. The original wires are connected to the new thermostat.

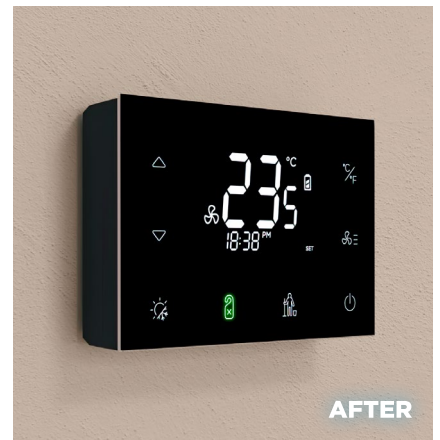

3c
In addition to controlling the fan coil, the glass touch thermostat can also transmit MUR/DND courtesy information to the in front of door panel RFGS-30S.

Battery powered fancoil thermostat



4a
If the wires do not lead directly from the original thermostat to the fan coil, or if it is connected differently (via systém) or you have no power supply, do not despair - we have a solution here too.



4b
We have a battery powered version of the RFTC-4 which is powered by 2xAAA batteries and communicates with the unit that is located at the fan coil or where the fan coil has its outlets.

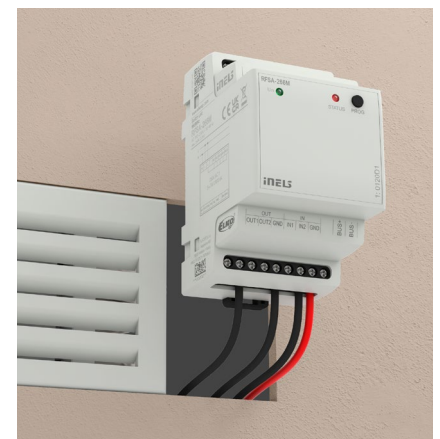

4c
The RFS-266M unit, designed to be mounted on a switchboard or directly to a fan coil, receives information from RFTC-4 and regulates temperature in the same way as RFTC-3 (direct control).

Detectors



5a
A magnetic contact located on the door sends information about the guest's entry and, together with the motion detector, sets the room occupancy function.



5b
Motion detector RFMD-200 is designed for ceiling mounting. In cooperation with the door detector, it sends occupancy information via the gateway to the HRS and sets the room accordingly.



5c
The RFWD-100 window detector blocks the thermostat and thus the heating/cooling in the room. At the same time, it notifies the service if the temperature exceeds a longer time.

Lighting control by DALI



6a
The DALI actuator allows you to control (ON/OFF) or dim up to 32 luminaires (DALI drivers) independently without worrying about flickering or overload.



6b
Installation is simple and can be done directly into the luminaire or near installation box.



6c
With one dimming actuator RF-DALI you can control/dim all luminaires in a room.



Actuators



7a
You can pair the control buttons with different types of actuators.

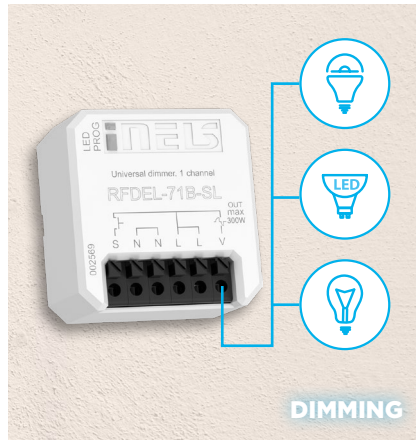

7b
RFDEL-71B-SL phase dimmer available for R-L-C-LED loads.

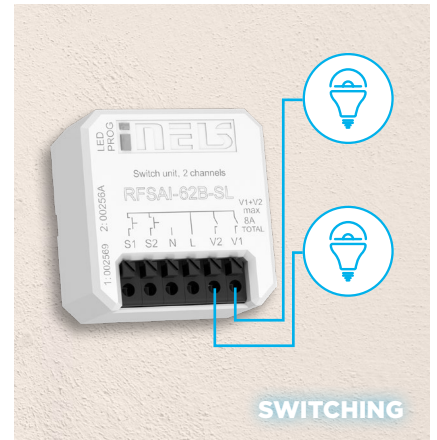

7c
The RFSAI-61B-SL (1x8A output) or RFSAI-62B-SL (2x8A outputs) can be used for switching. If you need to switch higher loads, then we offer the RFSAI-61B, which features 16A.

Bedside panel



8a
The iNELS system also remembers to retrofit the sockets in the bed so that they look identical together with the controllers.



8b
In the design of the glass RFGB, RFDW and RFSW controllers we also offer white or black glass frames for mounting different types of sockets: USB, HDMI, telephone ...



8c
In the interior, this combination forms a single compact unit and fits in with the design.

Curtains



9a

Buttons for controlling curtains or roller shutters can be programmed and engraved on the controls.



9b

The RFJA-32B-SL special actuator for two-ways control is built directly into the motor unit or the nearest electrical junction box.



9c

A short press moves it in steps, a long press pulls the curtains all the way back. These functions can be assigned to „welcome“ or „good night“ scenes.

Energy management

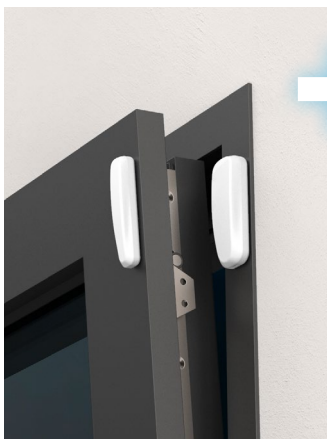

10a

Window detector blocks the thermostat and it does not heat/air condition.



10b

Motion detector together with door detector detects guest presence and activates Occupancy/Vacant function. This turns off unnecessarily lit lights.



10c

This causes the thermostat to switch to standby mode.

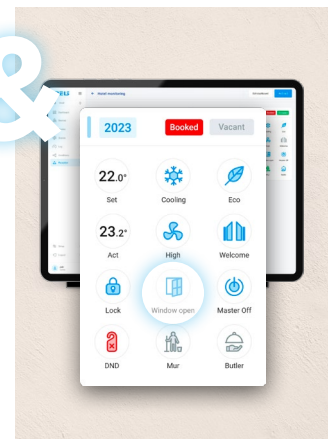

10d

This status is indicated on the HRS dashboard to the reception desk.

iNELS Hospitality offers a simple HRS (Hotel Reception Software) console that allows you to monitor the status of the room, including occupancy, MUR/DND and also allows you to control some of the functions: temperature, lighting, welcome scene. The software can be installed on a separate hotel server or it can be used in a Cloud version online. Also included is a smart phone app for housekeeping that provides information on occupancy and cleaning requests.

Room control card

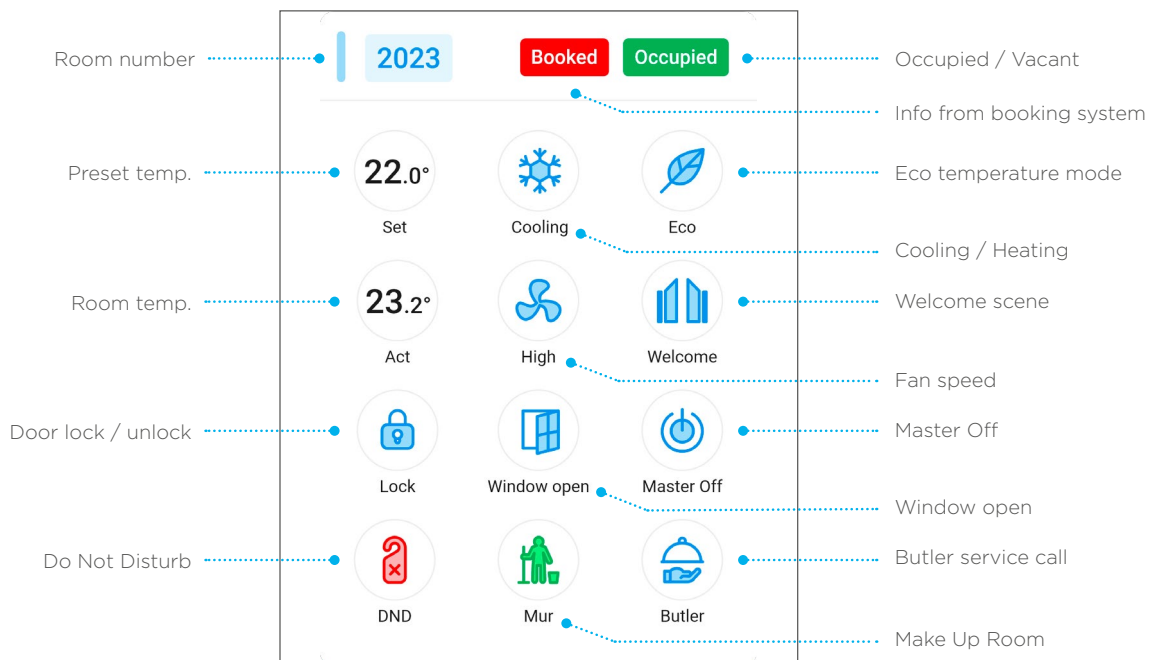

Floor overview

The screenshot displays the '1st Floor' overview in the iNELS software. It shows a grid of room control cards for rooms 201 through 206. Room 203 is highlighted in blue. To the right is a floor plan diagram. Below the grid is a 'Control center' for room 203, showing a set temperature of 22.0° and heating state. A 'Notifications' section lists recent events for rooms 101, 103, and 105.

Control center

Set Temperature	State of Heating	Mode
22.0°	Heating	Auto Eco 1 2 3

Notifications

Room	Event	Time
Room 101	MUR	06-06-2023 10:20
Room 103	MUR	06-06-2023 10:24
Room 105	Butler	06-06-2023 11:15

Service management

On the back-end, the supervisor can track and manage room service requests. Response time and delay performance can also be evaluated and measured.

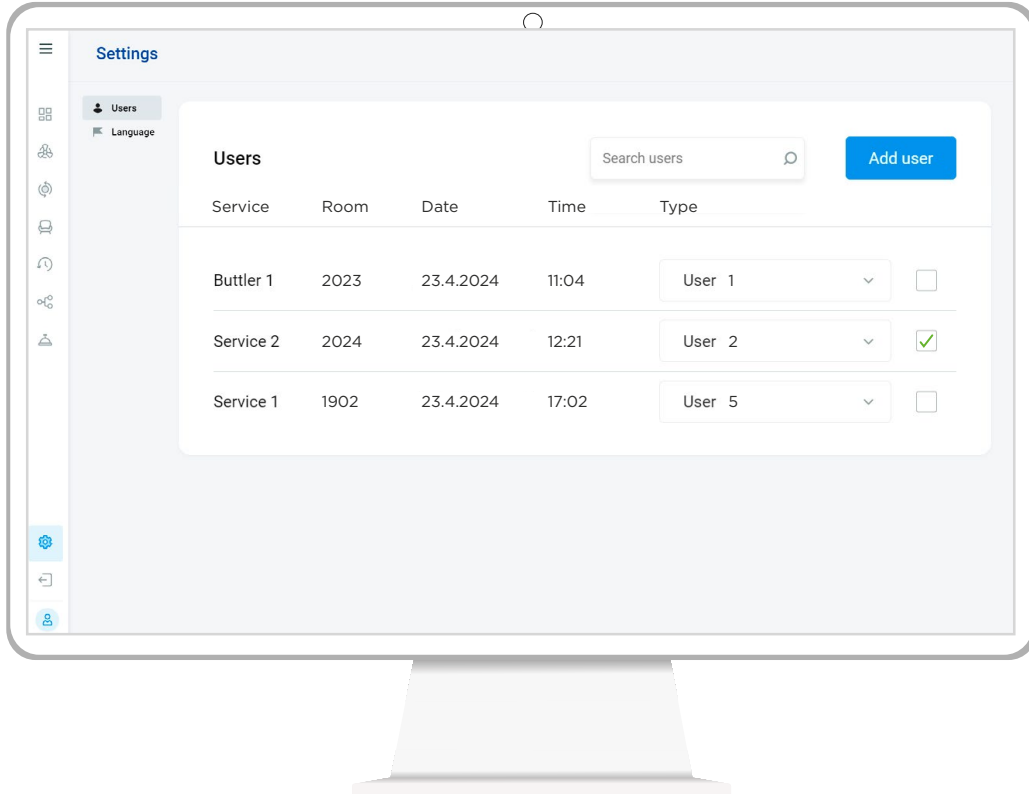

Devices management

Device overview with the option to view event history.

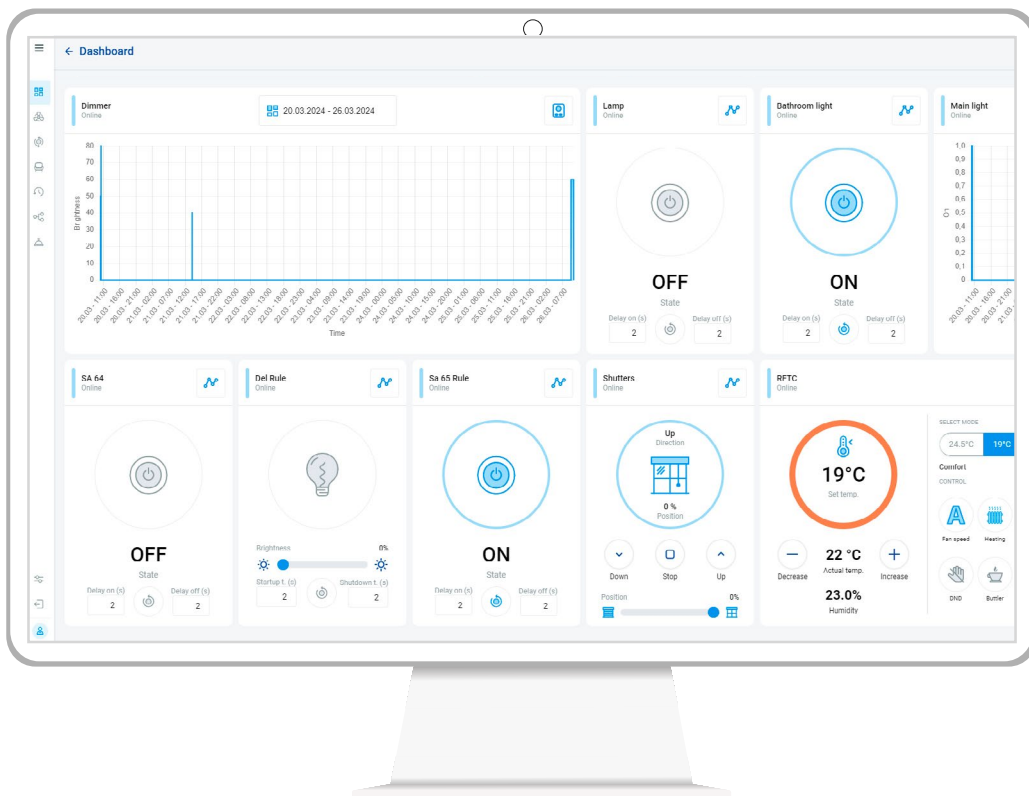

iNELS App

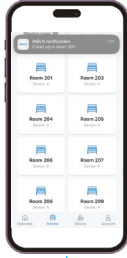

HRS - Hotel Room Software

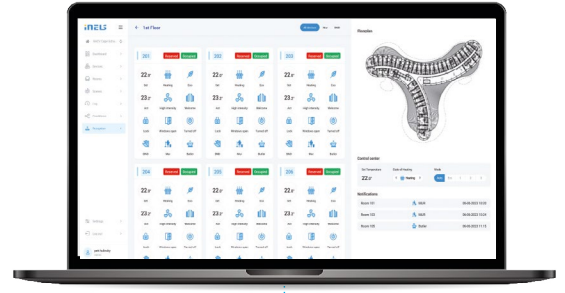

OR



Local Hotel Server on site



WIFI

Room 401



RFTC-3

Room 402



RFTC-3

Room 301



RF Touch-2

Room 302



RF Touch-2

ROOM 201



gateway eLAN-RF-103

ROOM 202



gateway eLAN-RF-103

HOTEL



HRS

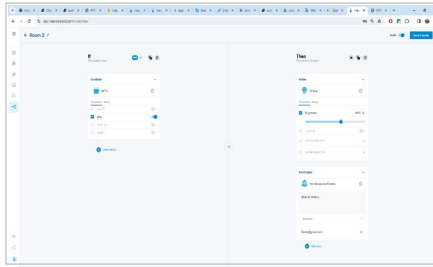

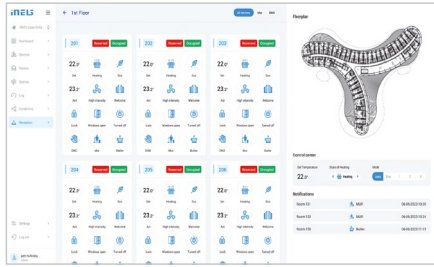

BACKEND

FRONTEND

NodeRED

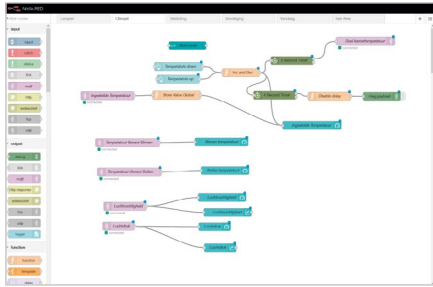

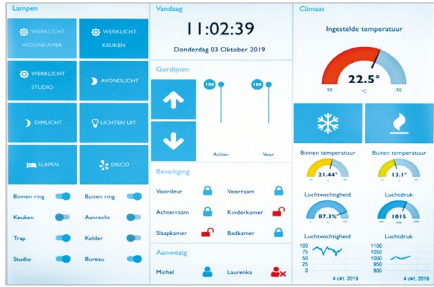

BACKEND

FRONTEND

SkyThings

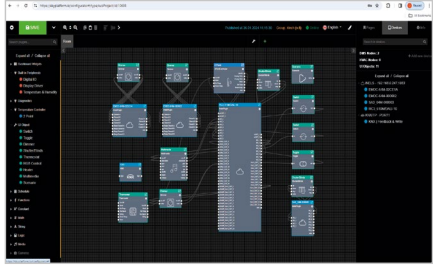

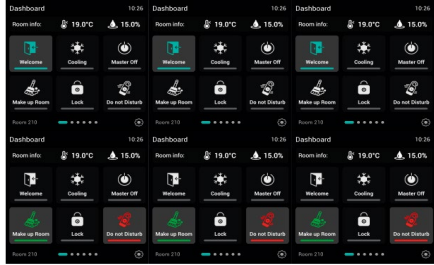

BACKEND

FRONTEND

PMS





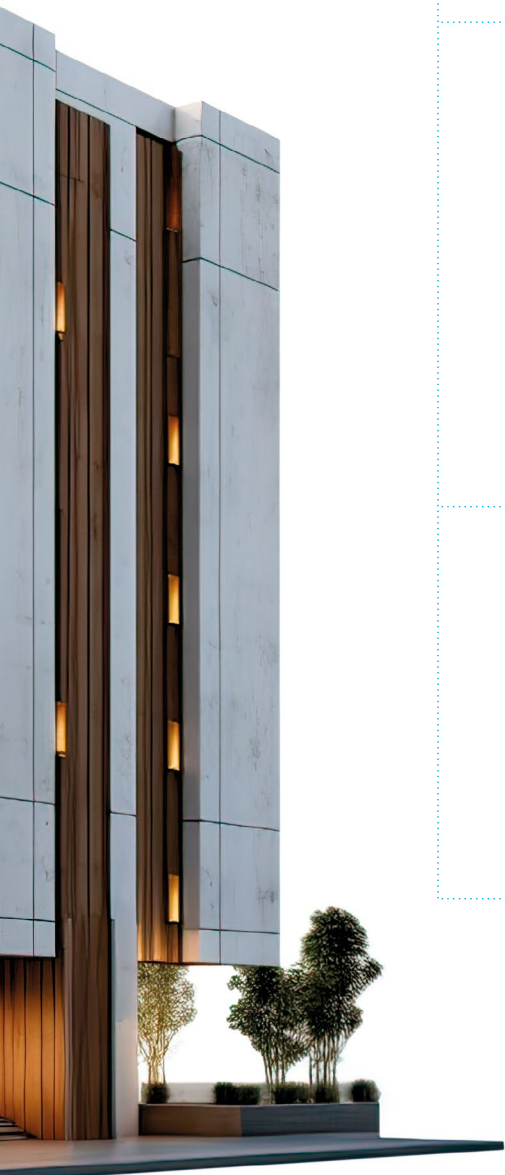

On-wall button controller

The RFWB-20 (2 buttons) and RFWB-40 (4 buttons) push-button controllers are offered in Logus⁹⁰ design with plastic keys in 5 colours and natural frames (nature plastic, coloured plastic, glass, wood, stone, metal). They can be combined in multi-frames. Powered by a CR2032 battery.

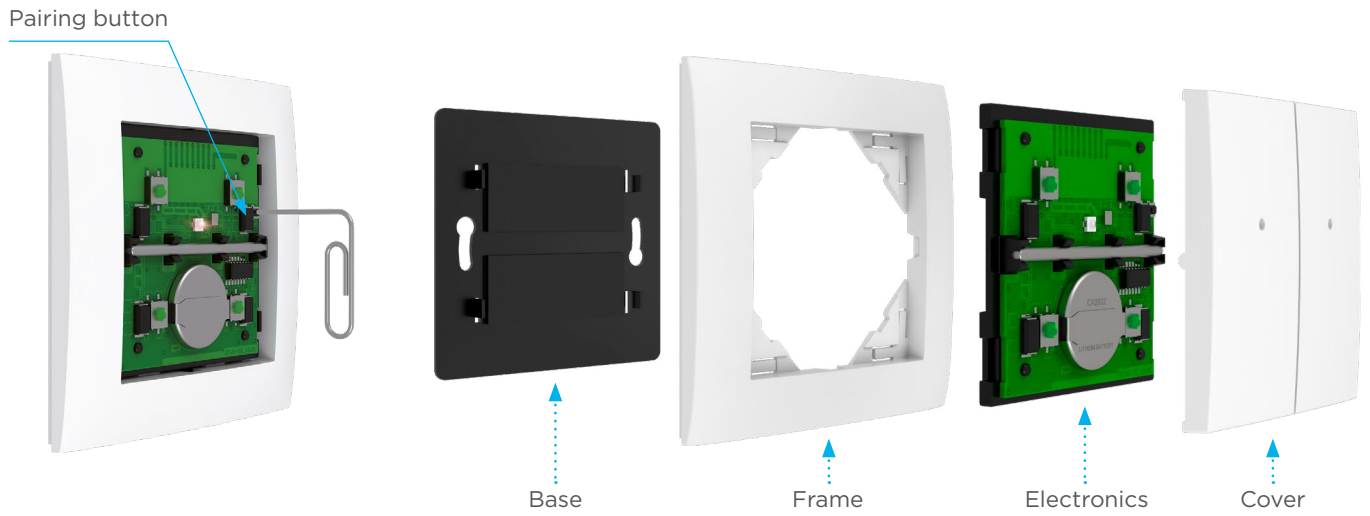

RFWB-20/G: 2 buttons
RFWB-40/G: 4 buttons

Logus⁹⁰ line

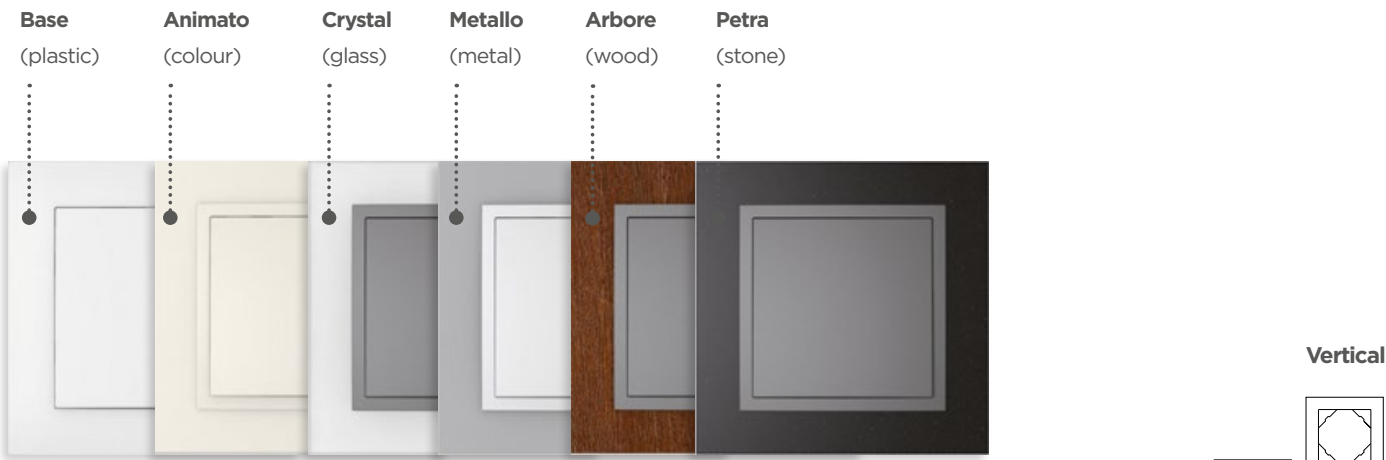

Combination in multiframe

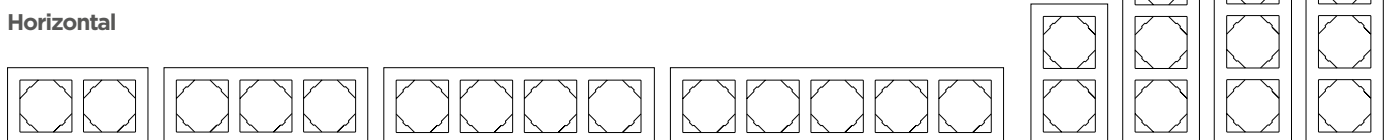

Glass touch thermostat for fancoils

The touch glass thermostat is designed for direct control of 2 or 4 pipes fan coils from built-in relays. In addition to setting the temperature, it allows to controll heating/cooling, switching fan speed. Displays room or set temperature, current time, humidity and operating conditions. For blocking, open window/door sensors, occupancy detector can be connected either wired or wirelessly. All setup is done via Wifi from the web setup page, communication is then to the supervision systems or application via MQTT.

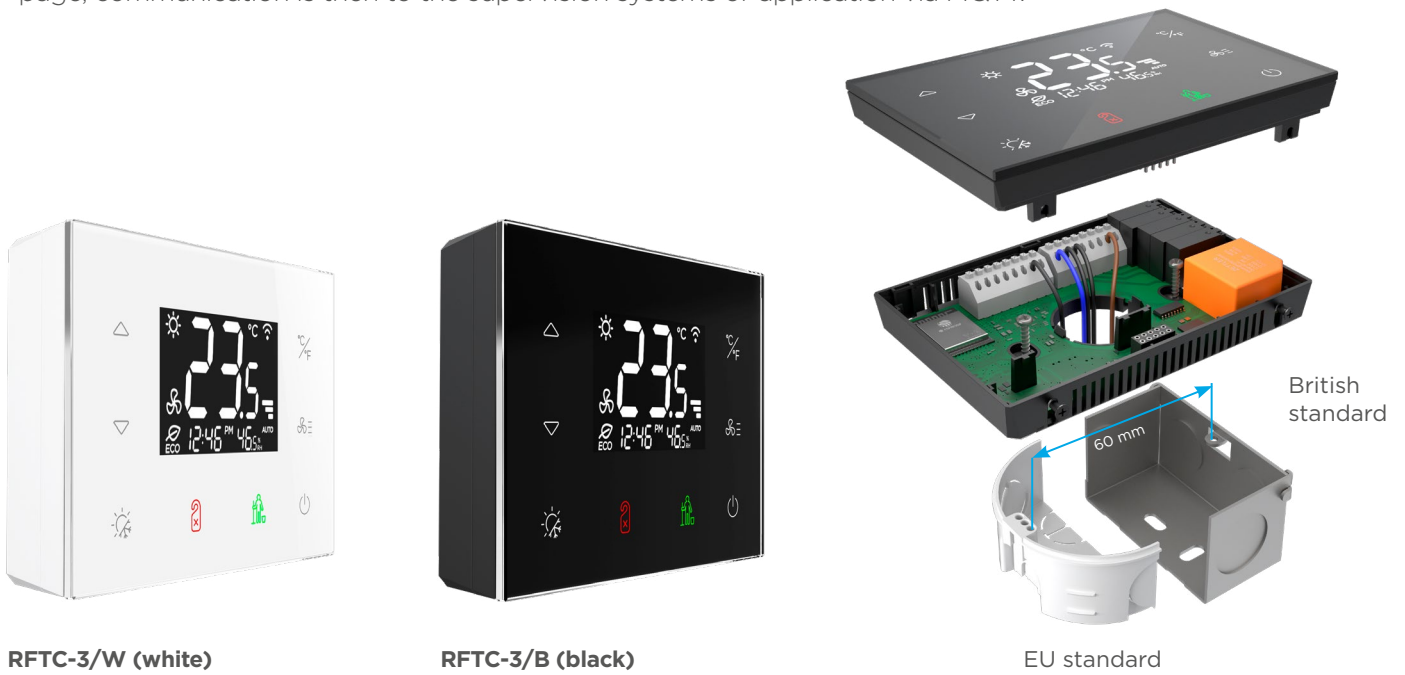

Glass touch controller

Glass touch controllers are the luxury option of the controllers in a hotel room. We offer them in 2 or 4 button versions, in sharp or rounded designs and in white or black glass. They can be glued with the included double-sided pads or screwed onto the installation box via an adapter. Powered by a 2x CR2032 battery. Of course, customization of icons and descriptions of the glass is possible.

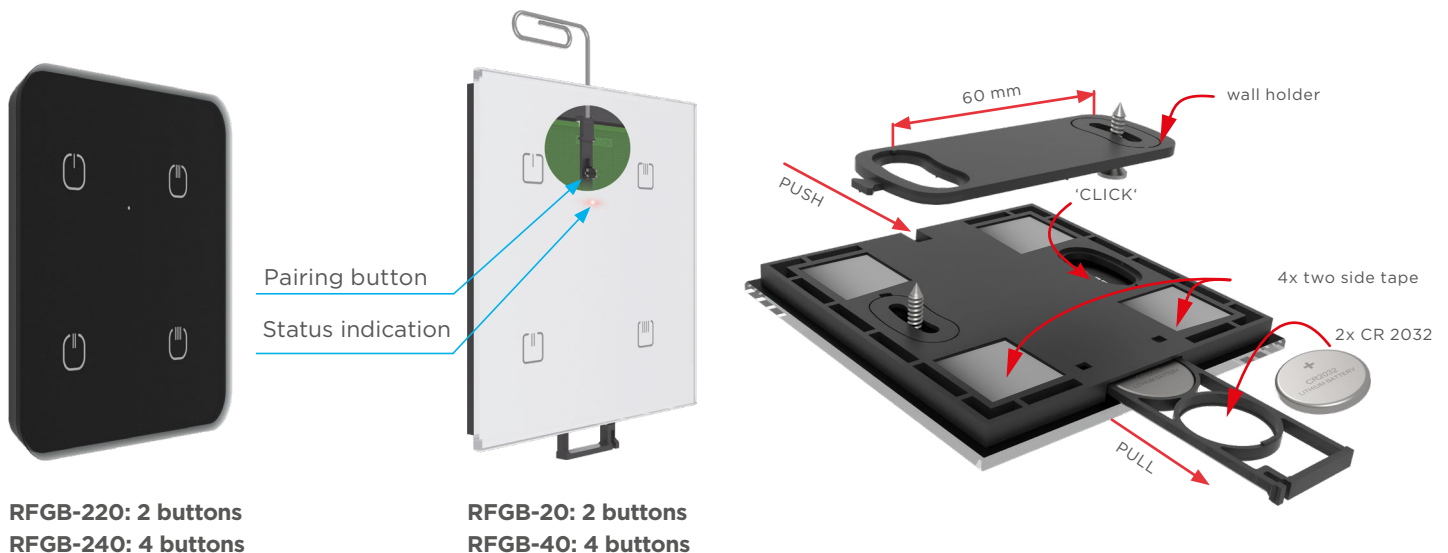

RFGB-220: 2 buttons
RFGB-240: 4 buttons

RFGB-20: 2 buttons
RFGB-40: 4 buttons



Glass touch thermostat battery powered

Same design as RFTC-3, but powered by 2x AAA batteries. It is suitable wherever there are no wires – with actuators communicates wirelessly. Can control fancoil actuator via RFSA-266M as well as flush mounted switch actuators or thermostatic valves.

The RFSA-266M (in DIN-rail formfactor) fancoil control actuator operates in the same way as the RFTC-3, but the actuator is placed close to the fancoil or control panel when the wires from the fancoil are terminated.



RFTC-4/W (white)
RFTC-4/B (black)

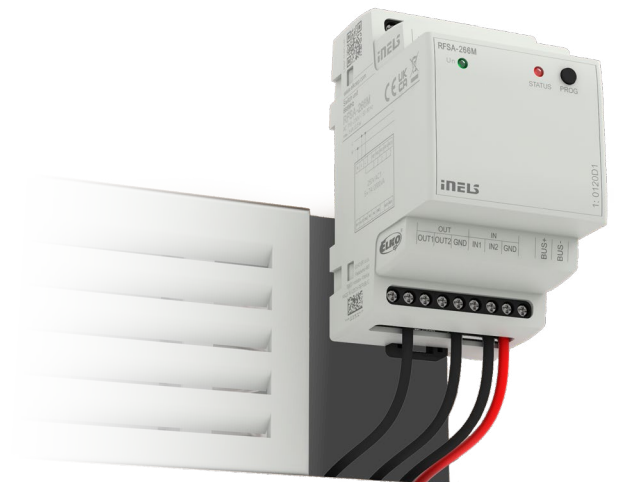

RFSA-266M



RFTC-4/W (white)
RFTC-4/B (black)



RFSA-266M

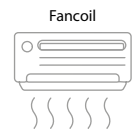

Fancoil



RFSAI-61B-SL

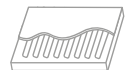

heating cable



RFATV-2



radiator



RFSC-61N



boiler



Infront of door hotel room unit

The RFGS-30 in front of door signaling glass panel is designed for MUR (Make Up Room) and DND (Do not disturb) signaling from in-hotel rooms. They also allow a bell button that indicates the presence of a guest in the room by the colour of its backlight. Power supply AC 230V or AC/DC 24V, wireless communication. A suitable installation in place of the original doorbell button.



RFGS-30/SB (black)
RFGS-30/SW (white)

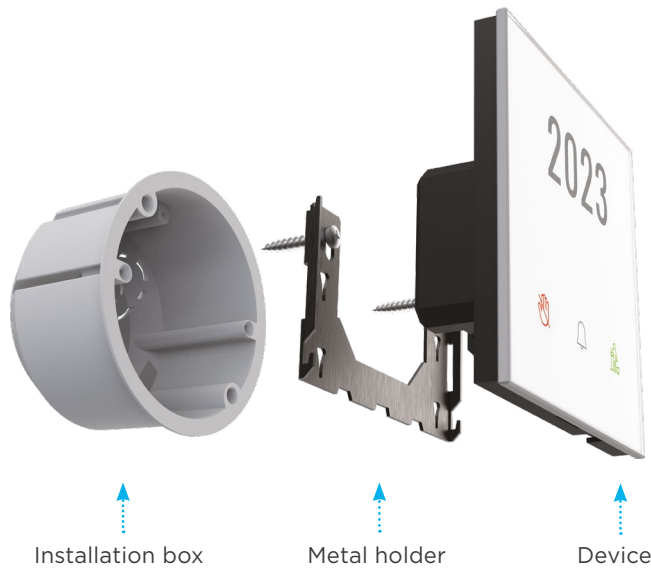

Installation box

Metal holder

Device

Glass touch wireless controller with symbols

This in-hotel room unit has three functions: 1) MUR/DND courtesy activation, 2) switching two independent light circuits, 3) It can control those lights in the same way as other actuators in the room - e.g. the Master OFF button turns off all lights when leaving or sleeping. Fully customisable design. Power supply AC 230V or AC/DC 24V, wireless communication.

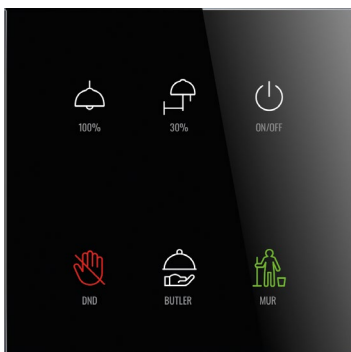

RFSW-62/SB (black)
RFSW-62/SW (white)



Installation box

Metal holder

Device

Motion detector

This wireless occupancy sensor is designed for ceiling mounting and communicates the presence of a guest in the room via the RFTC-3 thermostat. Accordingly switches temperature modes, turns lights on/off and notifies the reception dashboard. Powered by 2x AAA batteries.



RFMD-200

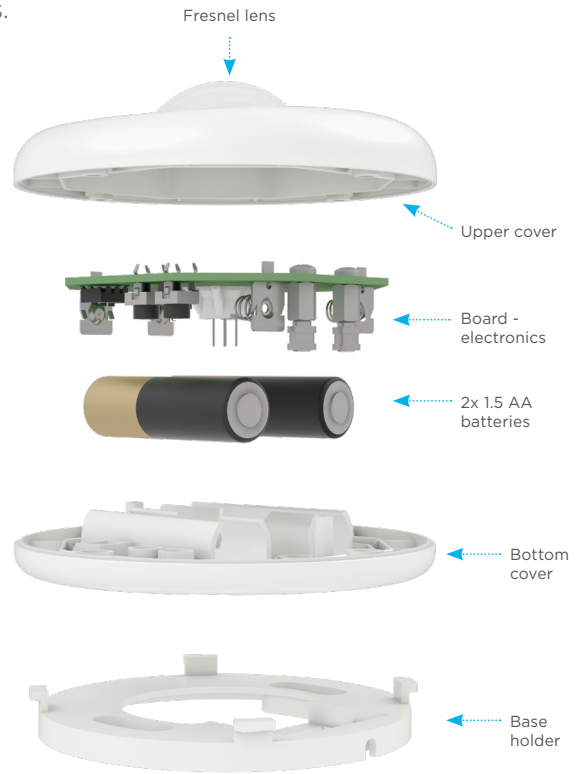

Window/Door detector

This wireless magnetic sensor detects the opening of a door or window and sends information via the gateway in the thermostat to the reception HRS dashboard. Opening the window also blocks the heating/cooling, while opening the door together with the motion sensor indicates the presence of a guest in the room. Powered by CR2032 battery.



RFWD-100

DALI controller, for 4/32 DALI addresses

Modern efficient wireless light control. No worries about bulb type or flicker with standard phase dimmer. It allows the connection of up to 4 (or up to 32) DALI ballasts (light circuits). The lights can then be controlled ON/OFF or dimmed continuously in 256 steps.

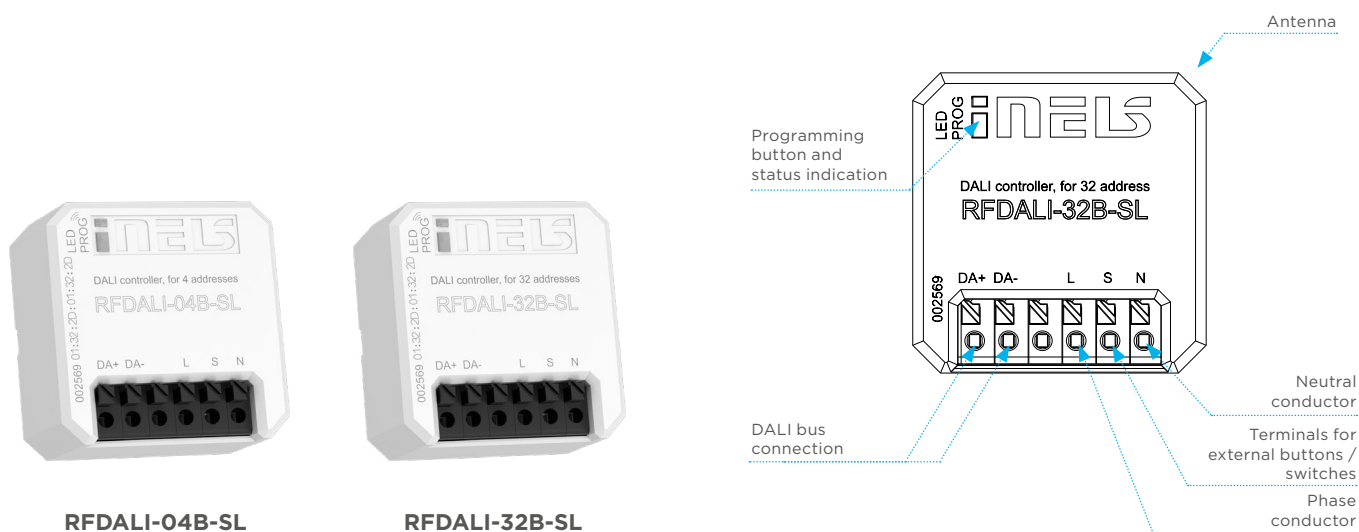

RFDALI-04B-SL

RFDALI-32B-SL

Switching actuator

In the box version, for flush mounted installation or directly into the light body, 1x or 2x 8A output contacts with zero-cross technology allow trouble-free switching also of problematic light loads (like LED, drivers). Existing wired switches can be connected to the external input terminals - if there is a requirement to retain them.

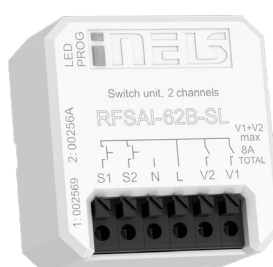

RFSAI-62B-SL

Dimming actuator

Phase dimmer with a maximum capacity of 300 VA can dimm all types of lighting loads (R, L, C, ESL, LED). Existing wired switches can be connected to the external input terminals if they are to be retained.

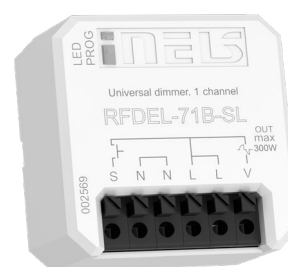
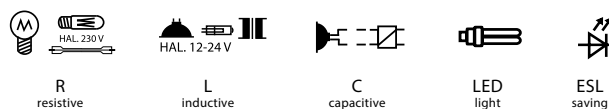

RFDEL-71B-SL

- 1** Infront of door hotel room unit
RFBS-30/S, 24V/230V powered

- 2** Glass touch controller with symbols and two outputs
RFSW-62/S, 24V/230V powered

- 3** Glass touch thermostat for fancoils
RFTC-4, battery powered, control RFS-266 M

- 4** Motion detector for ceiling mounting
RFMD-200, battery powered

- 5** Window/door detector
RFWD-100, battery powered

- 6** Glass touch controller, 4 buttons
RFG-40, battery powered

- 7** DALI controller, 4 DALI ballast
RFDALI-04/B-SL, 230V powered

- 8** Switch unit for fancoil control
RFS-266M

- 9** USB/LAN socket panel
GSS3-USB/LAN

- 10** Multistandard socket panel
GSS3-PMS

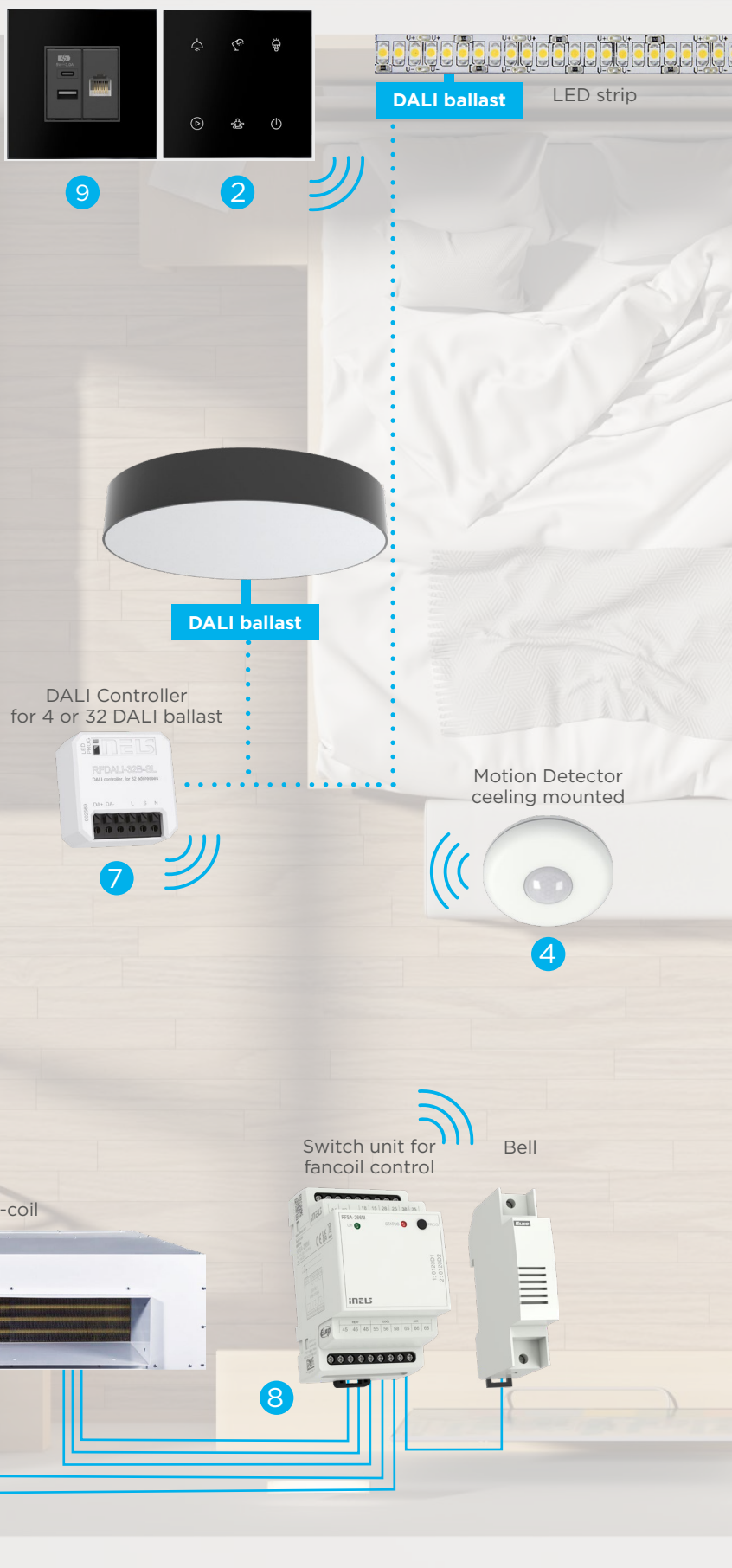

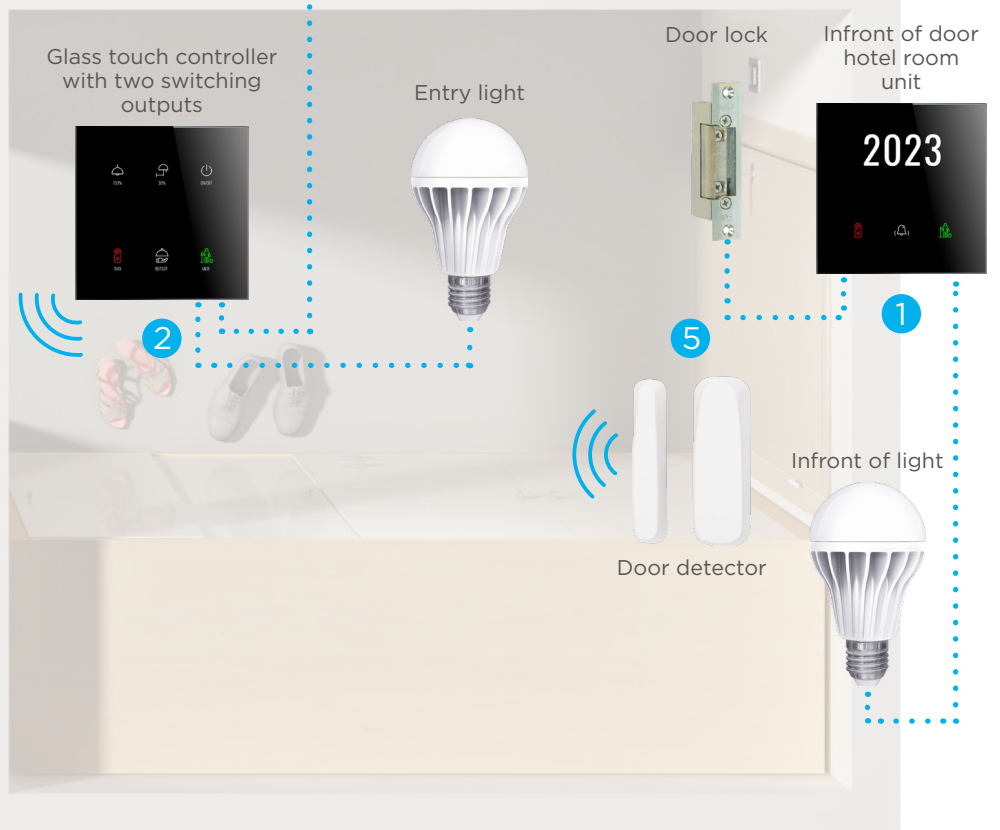
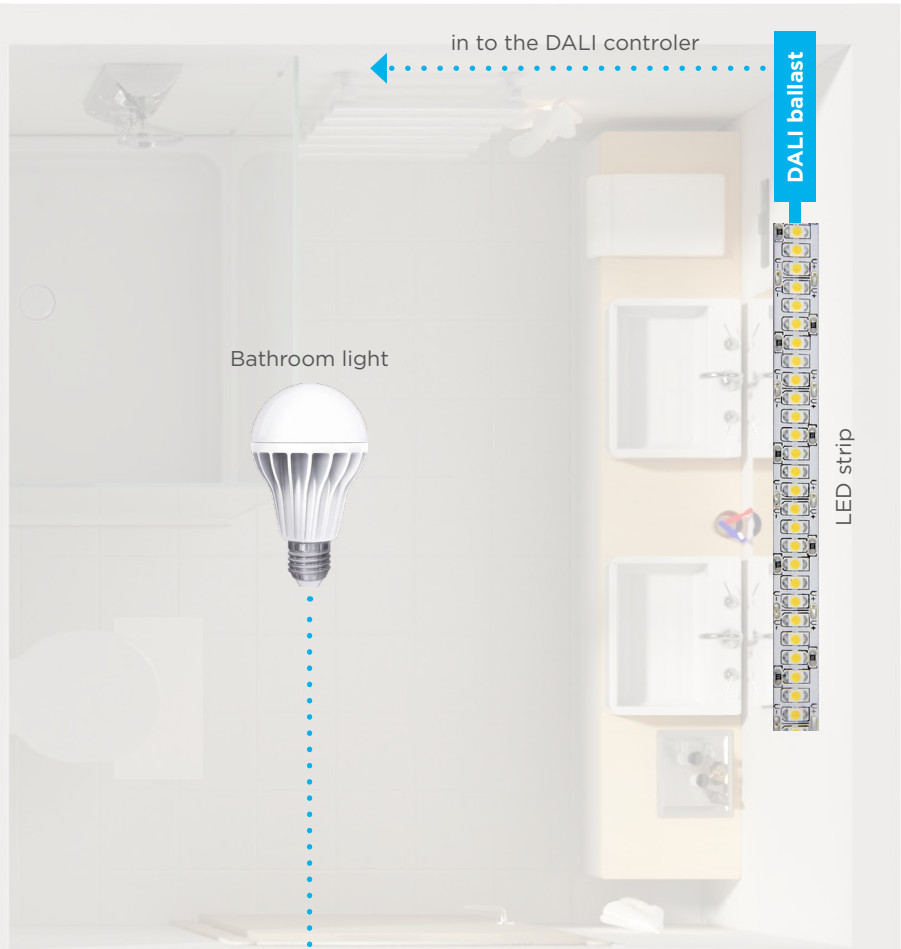

Controllers – natural design

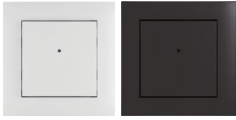

RFWB-20/G – white
RFWB-20/GB – black
On-wall button controller
- 2 buttons

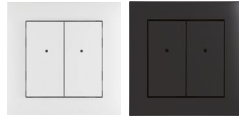

RFWB-40/G – white
RFWB-40/GB – black
On-wall button controller
- 4 buttons



Controllers – glass design



RFGB-20/W – white
RFGB-20/B – black
Glass touch controller
SHARP – 2 buttons

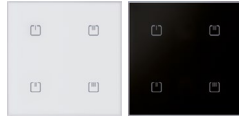

RFGB-40/W – white
RFGB-40/B – black
Glass touch controller
SHARP – 4 buttons



RFGB-220/W – white
RFGB-220/B – black
Glass touch controller,
ROUND – 2 buttons



RFGB-240/W – white
RFGB-240/B – black
Glass touch controller,
ROUND – 4 buttons

Controllers – glass with actuators



RFSW-62/B – black glass, SHARP
RFSW-262/W – white glass, ROUND
Glass touch controller
with output relays



RFDW-71/B – black glass, SHARP
RFDW-271/W – white glass, ROUND
Glass touch controller
with dimmer

Courtesy units – glass design

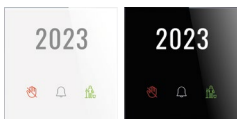

RFGS-30/SB – black glass
RFGS-30/SW – white glass
Infront of door hotel
room unit

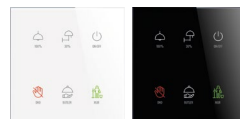

RFSW-62/SB – black glass
RFSW-62/SW – white glass
Wireless touch glass remote
control with symbols and two
output relays

Switch units – flush mounted



RFS-61B

Switch unit, 1 channel
– 1x 16 A, multifunction



RFS-61BPF-SL

Multifunction switch unit
with inputs for external
buttons – 1x 8 A, with galva-
nically separated contacts



RFS-61B-SL

Multifunction switch unit
with inputs for external
buttons – 1x 8A

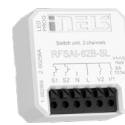

RFS-62B-SL

Multifunction switch unit
with inputs for external
buttons 2-channels, 2x 8 A
(total)



RFJA-32B-SL

Switch unit for shutters,
2x 8 A

Switch units – DIN rail mounted



RFS-61M

Switch unit, 1 channel – multi-
function, 1x 16 A



RFS-66MI

Switch unit, 6 channels with
integrated antenna
– multifunction, 6x 8 A



RFS-61MI

Switch unit, 1 channel with
integrated antenna
– multifunction, 1x 16 A



RFS-66M

Switch units, 6 channels
– multifunction, 6x 8 A

Dimmers – flush mounted



RFD-71B-SL

Analog controller,
0(1)-10 V
– multifunction



RFD-32B-SL RFD-04B-SL

DALI controller,
for 4/32 DALI addresses



RFD-71B-SL

Phase dimmer
1-channel – 1x 300 VA
– R, L, C, LED, ESL

Dimmers – DIN rail mounted



RFD-73M/RGBW

Dimmer for LED (RGB) strips,
3-channels



RFD-71M

Universal dimmer,
1-channel – 1x 600 VA
– R, L, C, LED, ESL



RFD-76M

Universal dimmer,
6-channels – 6 x 150 VA

Temperature control



RFTC-3

Glass touch thermostat for fancoils, 230 V



RFTC-4

Glass touch thermostat battery powered



RFTC-50/G

Autonomous temperature controller



RFTC-10/G

System temperature controller



TC TZ

External temperature sensors



RFATV-2

Wireless thermostatic valve



RFTI-20

Temperature and humidity sensor



RFSA-266M

Switch unit for fancoil control



RFSTI-11B-SL

Switch unit with external temperature sensor

Converters



RFIM-40B/BP-SL

4 input contacts converter battery powered



RFIM-40B/230-SL

4 input contacts converter AC 230 power supply



RFSG-1M

Input contact converter –1x permanent contact

Detectors



RFMD-200

Motion detector ceiling mounted



RFMD-100

Motion detector corner mounted



RFWD-100

Window/Door detector



RFSF-100

Flood detector

System units



eLAN-RF-103
Smart RF gateway
with LAN



RFRP-20N
Repeater to extend
the range



RF Touch-2/BE
RF Touch-2/BR
Wireless touch unit
– flush mounted

Accessories



RFAF/USB
Service Key



AN-I
Internal antenna
Gain: 2.1 dBi



AN-E
External antenna
Gain: 5 dBi



AN-E3
External antenna
Gain: 3 dBi, IP67



Extension cable for external
antenna
10 m

Metal frames for sockets

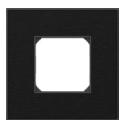

MSF3/B
Graphite black

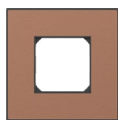

MSF3/C
Antique copper

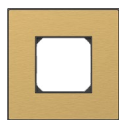

MSF3/G
Satin brass

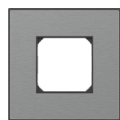

MSF3/S
Brushed silver



GSF3/B
Black glass



GSF3/W
White glass

Glass frames for sockets

Sockets



VM55SB-U
Multistandard socket
2-modules



EM68SB-U
USB A+C
1-modul



KM35SB-U
HDMI
1-modul



KM39SB-U+
KM50SB-U
LAN
1-modul



EM31SB-U
PIR
1-modul



TM21SB-U
Blind cover
1-modul



VM55SW-U
Multistandard socket
2-modules



EM68PW-U
USB A+C
1-modul



KM35PW-U
HDMI
1-modul



KM39PW-U+
KM50PW-U
LAN
1-modul



EM31PW-U
PIR
1-modul



TM21PW-U
Blind cover
1-modul

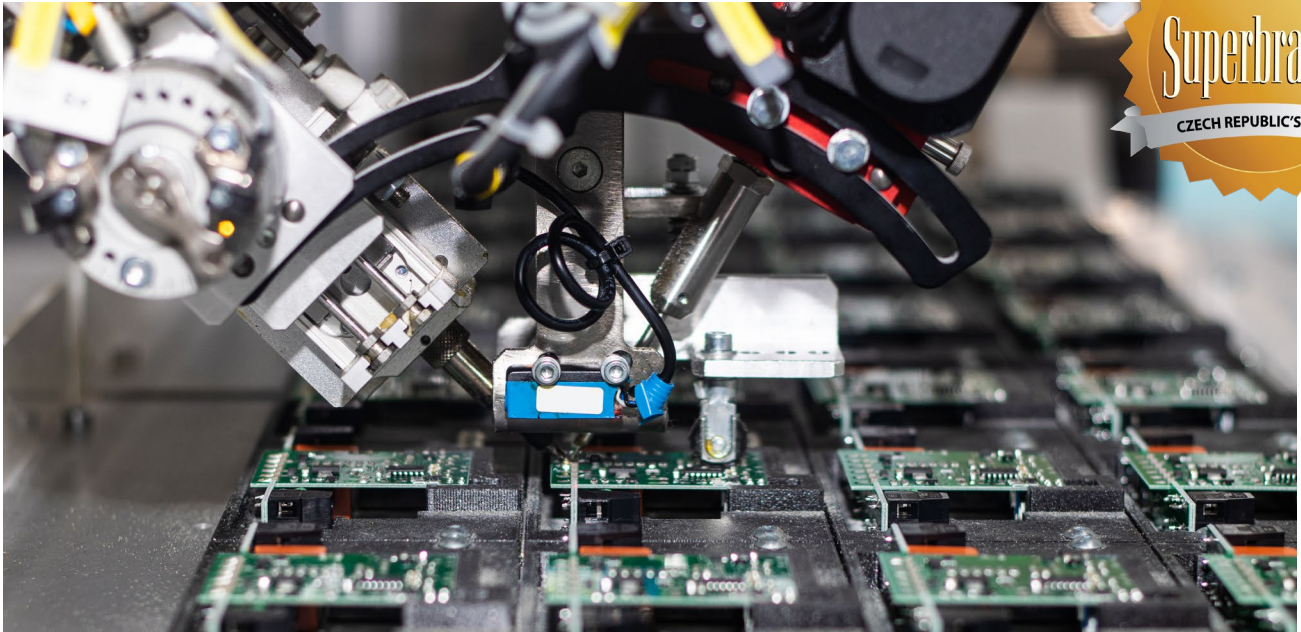

ELKO EP | Company introduction

ELKO EP have been your partner in the field for 30 years, developing and manufacturing the highest quality electronic devices for electroinstallation as well as Smart System for Residential and Building automation.

ELKO EP employs more than 350 people across 11 foreign branches and exports its products to more than seventy countries. Company of the Year, Visionary of the Year, Superbrands and Global Exporter of the Year are just some of the awards we have received throughout the years as we consistently strive to move forward in the field of innovation and development. Millions of relays, thousands of smart homes, hundreds of buildings and many satisfied customers - This is ELKO EP; a traditional company based in the center of Europe, where own development, production, logistics, and service are at the forefront of our focus.



Years

guarancy



Czech

made



Customization

welcome



350

employees
in holding



WORLDWIDE

11 branches
6 franchises
70 export countries



30 000 +

iNELS
installations



30 000 000 +

manufactured
products



R&D

continously
innovative



SUPPORT

24 / 7 / 365



MANUFACTURER

fully automated
complete proces



Marriott Marquis Hotel, West bay Qatar

Client: ARTIC
Contractor: ARMITI
Consultant: ARTIC
System: ELKO Master Switch
Function for Hotel Guest Rooms & Apartments
Total Floors: 43
Total Room: 450



Marasa Arabia (ST Regis Hotel & Apartments)

Client: AL Fardan Group
Contractor: CDC
Consultant: DAR
System: ELKO DIMMING SYSTEM
Total Room: 366 Apartments

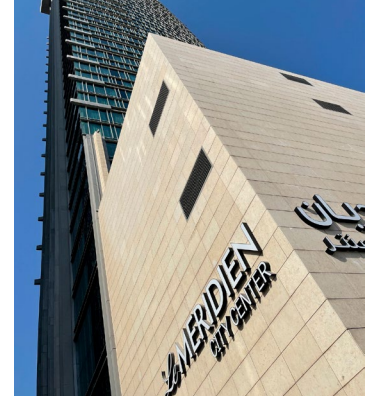

Le Meridien Hotel & Apartment

Client: ARTIC
Contractor: ARMITI
Consultant: ARTIC
System: ELKO Master Switch
Function for Hotel Guest Rooms & Apartments
Total Floors: 42
Guest Rooms: 256
Apartments: 171



Movenpick Hotel JLT

Client: IFA Hotels and Resortd
Contractor: Drake and Scull, Dubai, UAE
Consultant: Al gurg Consultants - Dubai, UAE
System: GRMS + Lighting Control System
Total Floors: 40
Total Room: 400



Amwaj Rotana - JBR, Dubai UAE

Client: N/A
Contractor : N/A
Consultant: N/A
System: Energy Saving System
Total Room: 268

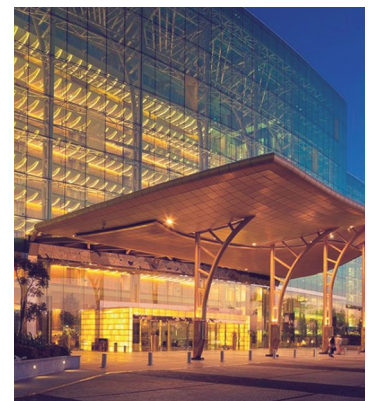

Meydan Dubai, UAE

Lighting control
Crystal chandelier
Starry night sky control
Audio/video system



● **Headquarters**

ELKO EP Holding SE, Czech Republic

● **Europe**

ELKO EP Balkan d.o.o
ELKO EP Bulgaria OOD
ELKO EP Germany GmbH
ELKO EP Hungary Kft.
ELKO EP POLAND Sp. z o.o.
ELKO EP SLOVAKIA, s.r.o.
ELKO EP UK Ltd.
ELKO EP UKRAINE LLC

● **Africa & Middle East**

ELKO EP Egypt LLC
ELKO EP Kuwait Ltd.
ELKO EP MEA LLC
ELKO EP Saudi Arabia Ltd.
ELKO EP South Africa PTY
Ltd.

● **America**

ELKO EP North America LLC



ELKO EP, s.r.o. | Palackeho 493 | 769 01 Holesov, Vsetuly | Czech Republic
phone: +420 573 514 221 | fax: +420 573 514 227 | elko@elkoep.com | www.elkoep.com

Published: 04/2024 | Modifications or amendments reserved | © Copyright ELKO EP, s.r.o. | 1st edition