

GBP3-60/BR/2F

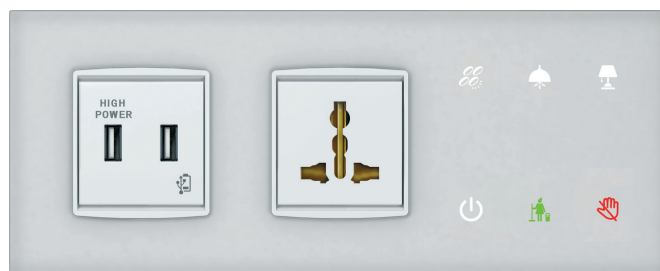

GBP3-60/WL/2F

EAN code

GBP3-60/BL/2F: 8595188135320
 GBP3-60/WL/2F: 8595188135337
 GBP3-60/BR/2F: 8595188157285
 GBP3-60/WR/2F: 8595188157292

Technical parameters	GBP3-60
Inputs	
Inputs:	2x AIN/DIN
Resolution:	by setting 10-bit
External temperature sensor:	YES, the connection between AIN1/DIN1 and AIN2/DIN2
Type of external sensor:	TC/TZ
Temperature measurement range:	-20 °C to +120 °C
Temperature measurement accuracy:	0.5 °C from the range
Illuminance sensor:	1 to 100 000 Lx
Buttons	
Number of control buttons:	6
Type:	capacitive
Indication:	coloured illuminated symbol
Outputs	
Acoustic output:	piezo-changer
Tactile output:	vibration motor
Communication	
Installation BUS:	BUS
Power supply	
Supply voltage/tolerance:	27 V DC, -20/+10 %
Dissipated power:	max. 0.5 W
Rated current:	25-50 mA (at 27 V DC), from BUS
Connection	
Terminals:	0.5 - 1 mm ²
Operating conditions	
Relative humidity:	max. 80 %
Operating temperature:	-20 to +55 °C
Storing temperature:	-30 to +70 °C
Protection degree:	IP20
Overvoltage category:	II.
Pollution degree:	2
Operation position:	any
Installation:	on the wall, observing the conditions for correct installation of the thermostat
Dimensions and weight	
Dimensions:	GBP3-60/1F: 165 x 94 x 36 mm, GBP3-60/2F: 236 x 94 x 36 mm
Weight:	according to the selected module

* Order codes are available in the INELS price list.

The picture of device is illustrative, the icons (symbols) and wiring accessories are configurable by the customer.

- Glass bedside panel GBP3-60 is part of a comprehensive range of iNELS control units for guest room management system (GRMS). Bedside panel is composed from 3-MODULE, of which one is module of touch buttons and two are modules to power for example mobile devices.
- The GBP3-60 is available in several designs, making it a very flexible and effective solution for a variety of projects. The following variants are available:
 - left/right version provides the same ease of operation from both sides of the bed.
 - 2-MODULE (1F)/3-MODULE (2F) design enables you to add a touch module with one or two power supply modules, network connection or multimedia.
 - black/white elegant design suitable for almost any interior.
- GBP3-60 panel is equipped with six customizable touch buttons whose function can be software adapted to the requirements of the investor. Of course there is the possibility of using the "Master OFF", then you can select functions for switching and dimming of lighting, shading control, different scenarios etc.
- Engraving of symbols is possible upon a request.
- GBP3-60 can be equipped with a number of modules, for example.
 - power AC sockets: French, British, Multi, and Shockproof
 - other types of modules: USB, LAN, Media
- The GBP3-60 panel is equipped with an ambient light sensor.
- Individual symbols can be illuminated in one of three colours - red, green and blue.
- GBP3-60/1F is designed for mounting into a double mounting box, GBP3-60/2F to a triple mounting box (distance between the centres of each of openings is 71 mm).

Connection

GBP3-60/xR/2F-23x-20x

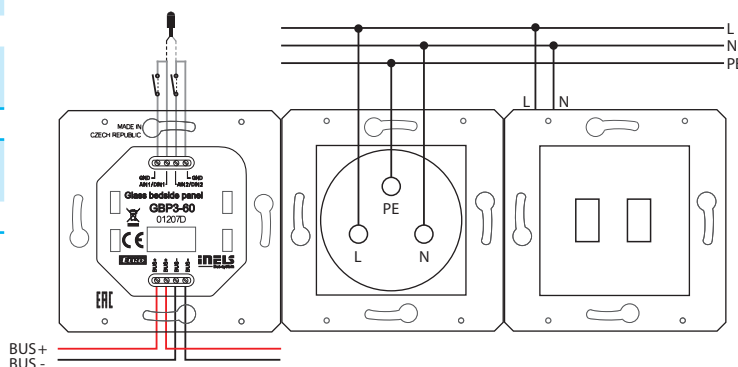

Switch

Push button



One switch /1M

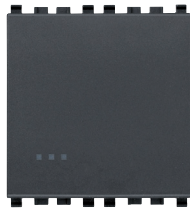

One switch /2M



Three switches



One Push button /1M



One Push button /2M

- 11B (20001) 12B (20001.2) 14B (20003)
- 11W (20001.B) 12W (20001.2.B) 14W (20003.B)

- 49B (20008) 50B (20008.7)
- 49W (20008.B) 50W (20008.7.B)

Socket



USA outlet



Schuko outlet



French outlet

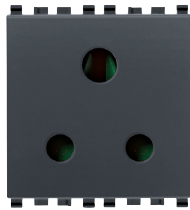

3 PIN outlet

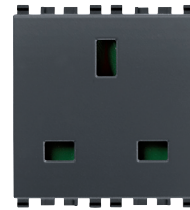

British outlet



Multistandard outlet

- 21B (20242) 22B (20208) 23B (20212) 24B (20214) 25B (20219) 26B (20257)
- 21W (20242.B) 22W (20208.B) 23W (20212.B) 24W (20214.B) 25W (20219.B) 26W (20257.B)

Data & Audio/Video



USB power supply unit



TV-FM-SAT socket outlet



VGA connector

- 20B (20295) 31B (20303) 32B (20348)
- 20W (20295.B) 31W (20303.B) 32W (20348.B)



TV outlet



Phone outlet



A/V connectors



UTP outlet



USB supply unit



Switch (CBs)



HDMI connector



USB outlet

- 41B (20313) 42B (20320) 43B (20335) 44B (20337.6) 48B (20292) 46B (20405.06) 47B (20346.H) 45B (20345)
- 41W (20313.B) 42W (20320.B) 43W (20335.B) 44W (20337.6.B) 48W (20292.B) 46W (20405.06.B) 47W (20346.H.B) 45W (20345.B)

(Number in brackets is original Vimar product code.)

Glass Bedside Panel

Configure bedside panel according to your request.

L (left option)

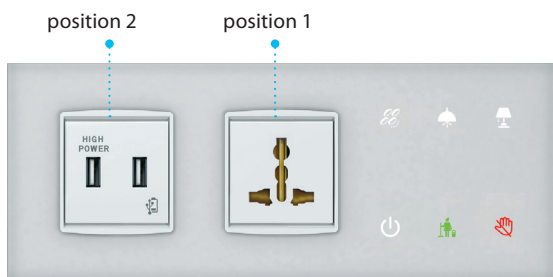

GBP3-60/WL/2F-26W-20W

R (right option)

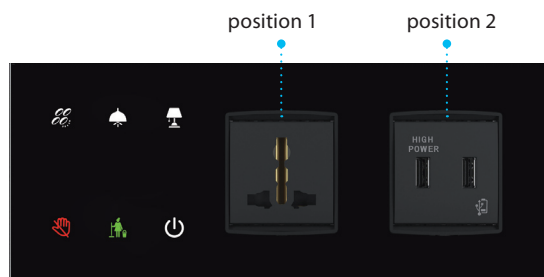

GBP3-60/BR/2F-26B-11B44B

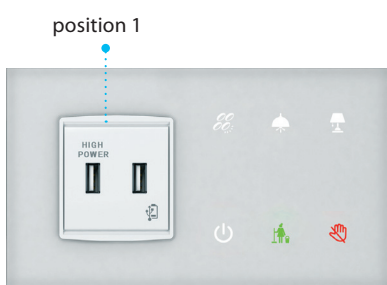

GBP3-60/WL/1F-20W

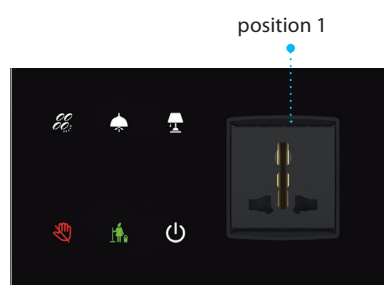

GBP3-60/BR/1F-26B

Part number

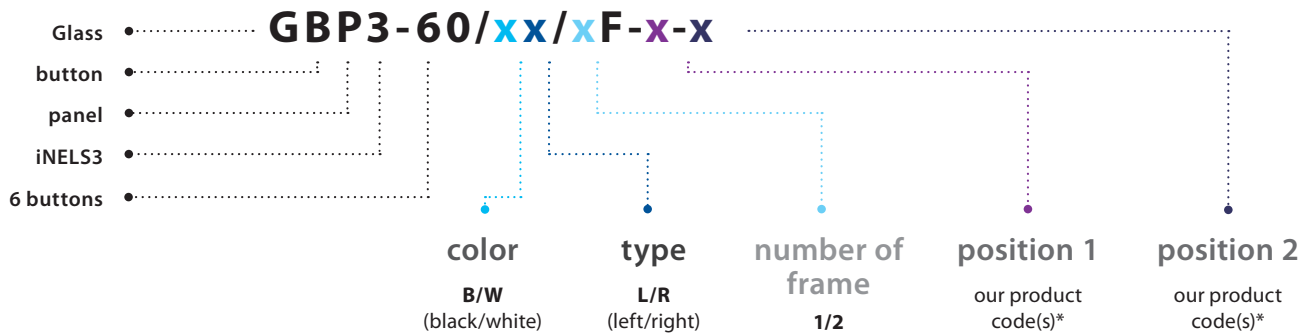

* In case of 1-MODULE choice it is necessary to pick 2x 1-MODULE to fill up the 1 position, for example GBP3-60/WL/1F-21W45W.

Classic plate



Glass white ice /2M



Glass black ice /2M



Glass black ice /3M



Glass black ice /4M

If you have any question contact our sales representative.
 For more information: www.vimar.com/en/int/catalog/product