



SHT-14/1

Multifunction time switch with Wi-Fi connection



Characteristics

- All programs in one device (daily, weekly, yearly and astronomical).
- Universal supply voltage in range of AC 110 – 230 V (50-60 Hz).
- Simple setting after the first start-up.
- Integrated super capacitor to back up the set time during power outages.
- Built-in web server for setup and control via Wi-Fi connection.
- Time synchronization through NTP server (require internet connection of time switches).
- Possibility of permanent connection to the local network.
- WRC: web remote control and setup from anywhere (require internet connection of time switches).
- Without display in 1-module housing.
- ASTROnomic program: manual entry of coordinates or selecting from one of more than 500 preset cities.
 - selection of days of the week
 - astro interrupt function (night break): controls the sunrise/sunset times and compares them with the set OFF/ON times
 - high position accuracy thanks to two decimal places in latitude/longitude
- 1-channel design (with an operating hours counter).
- Pulse/cycle output mode.
- Transition of summer/winter time – AUTO or OFF.
- PIN code protection against unauthorized changes.
- Wireless firmware update - **current version 1.59**

After connecting the product to the power supply and pairing Wi-Fi with the configuration device, you will be guided through the initial setup after opening the web interface.

In the event of a power outage, the device will retain all the set values required for reliable switching after the power is restored (max. duration is 30 h). After installation, it does not require any special service or maintenance.

The astronomical program does not need any optical sensors or other external devices to function. Its operating principle is that during the year every day, based on an algorithm and real-time (set in the time switch), automatically controls switching on and off times of e.g. public lighting. This is because the sunrise and sunset times change throughout the year. With the offset (deviation) function, the turning ON and switching OFF times can be corrected within ± 300 minutes. The offset is fixed for each day.

- Operation modes of switching:
 - *TIME PROGRAM* (switches according to set time programs)
 - *HOLIDAYS / TIME PROGRAM* (switches according to set holidays and time programs)
 - *ASTRO / TIME PROGRAM* (switches according to the set astronomical and time program)
 - *HOLIDAYS / ASTRO / TIME PROGRAM* (switches according to set holidays, astronomical and time program)
 - *RANDOM PROGRAM* (switches randomly in an interval of 10-120 min)
 - *LOCKED – MANUAL* (fixed output state that cannot be changed other than through settings)
- Possibility to manually control the output contact at any time (outside the operation mode, *LOCKED – MANUAL*).
- The time switch can work in CLIENT and AP wireless communication mode independently of each other.
- 200 memory locations for time programs.
- Up to 30 memory locations for holidays.
- Optional languages – CZ / EN / SK / HU / PL / ES / DE / BG / RU / UA / HR / SLO / RS
- Selection of summer/winter time transition:
 - AUTO (changes automatically according to the entered time zone)
 - OFF (permanently switched off winter/summer time transition)
- The time switch is equipped with a supercapacitor, which backs up the set time during a power outage. All settings and programs are saved in memory in the event of a power outage - they can thus be restored even in the event of a power outage together with a discharged capacitor. However, a time correction will need to be made.

Description

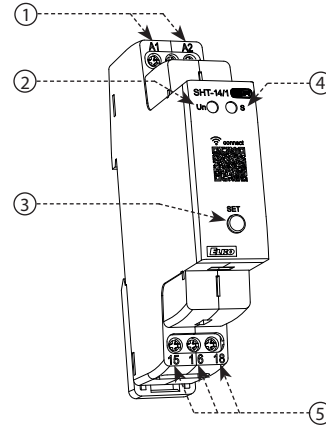

1. Supply terminal (A1-A2)
2. Supply voltage indication
3. Control button SET
4. Indication of operating states
5. Output - 1. channel (15-16-18)

BEHAVIOR UNDER VOLTAGE AND IN SLEEP MODE

Under voltage: The time switch indication is active, with a steady green LED indicating the presence of supply voltage. A red LED shows the state of the output contact or the type of manual control.

Sleep Mode: In the event of a power outage, the time switch goes into sleeping mode. In this state, the set time is backed up for a maximum of 30 h. The LEDs do not indicate the presence of supply voltage or the state of the output contact.

Connection

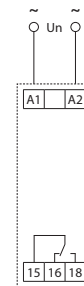

Prescribed minimum output protection: class B circuit breaker 16A.

Symbol

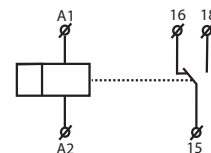

Control description

Device differs short and long button press. In the manual marked as:

- - 1× short button press (< 1s)
- - 2× short button press (< 1s)
- ☉ - 1× button press (> 1s)
- ☉ - 1× long button press (> 5s)
- - 1× long button press (> 10s)
- ☉ - 1× dlong button press (> 15s)

NTP TIME SYNCHRONIZATION

If NTP synchronization or client connection was previously configured through the web interface, the NTP synchronization can be launched on SHT-14 by pressing SET button (> 5s). The green and red LEDs flash 3× alternately.

Technical parameters

SHT-14-1

Supply terminals:	A1-A2
Supply voltage:	AC 110 – 230 V (50-60 Hz)
Consumption (max.):	Wi-Fi "OFF" 0.35 W/0.8 VA "ON" 0.80 W/1.5 VA
Supply voltage tolerance:	-25 %; +10 %

Output

Contact type:	1x changeover (AgSnO ₂)
Current rating:	16 A/AC1
Breaking capacity:	4000 VA/AC1, 384 W/DC1
Inrush current:	30 A/< 3 s
Switching voltage:	250 V AC/24 V DC
Power dissipation (max.):	1.2 W
Mechanical life:	30.000.000 ops.
Electrical life (AC1):	100.000 ops.

Time circuit

Accuracy:	max. ±0.5 s/day at 23°C (73.4 °F)*
Min. switching interval:	1 s
Data retention time:	min. 10 years
Set time backup:	30 h**

Program circuit

Number of memory locations:	200 - time programs, 30 - holidays
Program type:	daily, weekly, yearly, astro
Settings via website:	by Wi-Fi (2.4 GHz)

Other information

Operating temperature:	-15 .. +50 °C (-4 .. 131 °F)
Storage temperature:	-30 .. +70 °C (-22 .. 158 °F)
Dielectric strength: supply – output	AC 4 kV
Operating position:	any
Mounting:	DIN rail EN 60715
Protection degree:	IP40 front panel/IP20 terminals
Overvoltage category:	III.
Pollution degree:	2
Cross-wire section – solid/ stranded with ferrule (mm ²):	max. 1x 2.5, 2x 1.5/ max. 1x 2.5 (AWG 12)
Dimensions:	90 x 17.6 x 64 mm (3.5" x 0.7" x 2.5")
Weight:	71 g (2.5 oz)
Standards:	EN 61812-1

* If not synchronized through NTP server.

** The capacitor reaches its full capacity after about ten minutes from the connection of the supply voltage.

LED indication

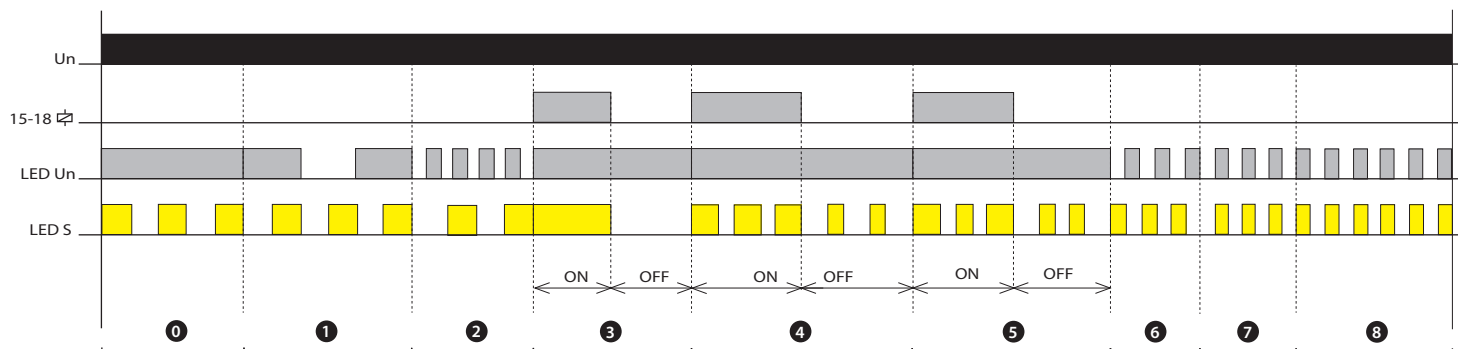

- 0 After connecting to the power supply (no internal time set *).
- 1 After activating the Wi-Fi access point, the AP (no internal time set *).
- 2 After Wi-Fi pairing with the configuration device (no internal time set *).
- 3 Closing/opening of the output contact based on the time/astromical program.
- 4 Closing/opening of the output contact based on temporary manual control.
- 5 Closing/opening of the output contact based on permanent manual control.

Manual output control

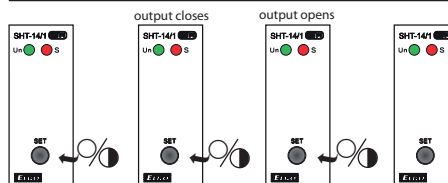

The red LED indication changes depending on the selected type of manual control.

- - 1x short press (< 1s)
- - 2x short press (< 1s)

We have two types of manual controls available:

- Permanent - 2x short press of the SET button (the symbol on the website lights up) The second highest priority of all control modes. The state of the output cannot then be changed other than by manual change (e.g. by switching to temporary manual control or by activating mode LOCKED - MANUAL, which has a higher priority). The last option is to deactivate this control mode.
- Temporary - 1x short press of the SET button (the symbol on the website flashes) Temporary manual control has the same priority as the previous, permanent one. However, it can be changed in the future, unlike permanent manual control, by one of the programs with a lower priority (if configured in the time switch). With power supply disconnection or when adding 1st time program, temporary manual control is deactivated.
- For manual control with delay, use the web interface - "Manual control" tab.

Modes priority

	symbol	mode/program
highest priority	▶▶▶▶▶	locked - manual control
	▶▶▶▶▶	manual control (temporary/permanent)
	▶▶▶▶▶	random
	▶▶▶▶▶	holidays
	▶▶▶▶▶	time
lowest priority	▶▶▶▶▶	astronomical

(symbol flashes on the website)



Warning

This device is constructed for connection in 1-phase network AC 110 – 230 V and must be installed according to norms valid in the state of an application. Installation, connection, setting and servicing must be carried out by qualified electrician staff only, which have perfectly understood the instructions and functions of the device. This device contains protection against overvoltage peaks and disturbing impulses in the power supply network. For the correct function of the protection of this device, there must be suitable protections of higher degrees (A,B,C) installed in front of them and according to the standards, interference of switching devices must be securely eliminated (contactors, motors, inductive loads, etc.). Before installation, make sure that the device is de-energized and the main switch is in the "OFF" position. Don't install the device to sources of excessive electromagnetic interference. Ensure correct installation by perfect air circulation so that during continuous operation and a higher ambient temperature, the device does not exceed the maximum allowed operating temperature. For installation and setting use a screwdriver with a width of approx 2 mm. Keep in mind that this is a fully electronic device and approach accordingly with the installation. Non-problematic function of the device is also dependent on the previous method of transportation, storage, and handling. In case of any signs of damage, deformation, malfunction, or missing parts, don't install this device and claim it at the dealer. The product must be treated as electronic waste at the end of its life.





- 6 Starting time synchronization using NTP server (must be configured using WEB).
- 7 Restarting the times switch.
- 8 Factory setting of the time switches.

* An unset internal time is indicated by slow flashing of the red LED (see point 0, 1, 2).

Display indication

	time program is active
	astro program is active
	random program is active

The indication can be found on the website in the „Overview“ and „Manual control“ menus.

	holiday is active
 	temporary permanent manual control
 	pulse program is active cycle program is active

First setup

You set the time switch via the web interface using the configuration device, by connecting the relay to the supply voltage and pairing with the Wi-Fi of the time switch.
In the first step, activate the Wi-Fi of the time switch by pressing the SET button (>1 s). The green LED starts flashing.

Now connect your configuration device (PC/Mobile/Tablet/....) to Wi-Fi (2.4 GHz) of the time switch SHT-14.

SHT-14 Wi-Fi access data (default):
SSID hostname: SHT-14_barcode number
Password: elkoep14
Web address for configuration: 192.168.1.1 or sht-14_barcode number.local

Setup wizard will guide you through each step after opening the configurator (web address).

ASTRO SETTINGS:

Menus for ASTRO settings (mode, output behaviour, astro interrupt, offset, location) will pop up only if you have selected one of the ASTRO programs as operation mode. You can find more information about setting up the astronomical program in the setup wizard on the website and also in the right column.



<https://www.elko.li/sht-14-First-setup>

If you need advice on the individual steps, follow the instructions below in the [Wi-Fi connection](#) headline.

Wi-Fi connection

First, make sure that you have a configuration device (PC/phone/...) with Wi-Fi of 2.4 GHz band that supports a web browser and is close enough to SHT-14 that you want to connect.
The time switch does not support a 5 GHz band.

It is possible to connect directly to the web server for configuration via the Wi-Fi generated by the SHT-14 (no router or internet connection required). If the time is to be synchronized, an internet connection via a Wi-Fi router is necessary.

Activating the Wi-Fi of time switch:

After connecting the SHT-14 to the power supply, it is possible to activate/deactivate Wi-Fi by pressing the SET button (> 1s).
If Wi-Fi is active and the configuration device is not connected, it will automatically turn off after 90 seconds.

NOTE.: Wi-Fi can be activated permanently through the settings, once the setup wizard is complete

Now connect your configuration device to the Wi-Fi of the time switch (follow the instructions provided by the manufacturer of the configuration device).

SHT-14 Wi-Fi access data (default):
SSID hostname: SHT-14_barcode number
Password: elkoep14

After the connection is established, green LED on the panel starts flashing at a higher frequency.

Open the web browser of the configuration device and enter the IP address in the address bar: 192.168.1.1



active Wi-Fi (AP) is indicated by green flashing LED on the panel of device



<https://www.elko.li/sht-14-Wi-Fi-connection>



Astro settings

ASTRO MODES:

SUNSET-ON (output of the selected channel closes at sunset)
SUNSET-OFF (output of the selected channel opens at sunset)
SUNRISE-ON (output of the selected channel closes at sunrise)
SUNRISE-OFF (output of the selected channel opens at sunrise)
INACTIVE (output of the selected channel does not respond to sunrise or sunset)

ASTRO INTERRUPT:

It works on a similar principle as a time program with the difference that the set OFF and ON times are compared by an algorithm with sunset and sunrise times. Possible offsets for the sunset and sunrise are counted together with a set offset for time OFF and ON in the astro interrupt submenu. In practice, it can be used e.g. for the so-called night break at set astro mode SUNSET-ON, SUNRISE-OFF (e.g. street light control).

With the above configuration, astro interrupt ensures that when the value for set time OFF + its offset is before sunset, the contact did not open. When the value for set time OFF + its offset is after sunset, the contact opened (night break start).

Likewise, astro interrupt takes care if configured like above that when the value for set time ON + its offset is after sunrise, the contact did not close. When the value for set time ON + its offset is before sunrise, the contact closed (night break end).



Date and time setting



Other settings

TIME CORRECTION:

Steps of 1 minute/year.
The numerical value is relative to minutes per year. The time correction is set at the factory and is individual for each product, so that the current time clock runs with minimal deviation. The time correction value can be changed arbitrarily, but after factory reset the value will be set back to the factory value.



Time program/holiday setting + delete all

Time program setting



Holiday setting



Local network connection

• Go to the "service" tab using the drop-down menu

Activate the „Active“ checkbox in the SHT-14 Wi-Fi (CLIENT) item and click the „Change“ button. You will now be prompted to fill in the access data of your Wi-Fi network to which you want to connect the time switch.

If you understand the given configuration, you can also choose static IP assignment. Otherwise, we recommend choosing the DHCP client option. After filling in the data, click the "Save" button. Now your time switch should be connected to the local network. You can verify this by reloading the given website, when the newly added data should be displayed in this item.

For example: An IP address that you can use within the local network to set up/control the time switch instead of the basic 192.168.1.1, which is used for a direct connection (configuration device > time switch).



Firmware update / restart / factory reset

• Firmware update:

The web interface will guide you through the update process. After connecting to Wi-Fi SHT-14 and opening the interface in the browser, go to the Service menu, select the file with the new firmware and click the update button.

Do not disconnect the power supply/Wi-Fi during firmware update!

After FW update in OS Windows, clear your browser cache if it allows it. To do this, you can use the keyboard shortcuts CTRL + F5 when loading the web interface. In case you don't know how to do it, the browser usually deletes it automatically within 5 minutes after loading the web interface. If the power supply/Wi-Fi was disconnected during the firmware update, the device might not work properly and in that case please get in touch with our technical support.

The SET button has functions depending on the length of the press:

• Restart:

It is performed by long pressing (> 10s) the SET button. Green, red LED flashes 3 times

This step will not result in loss of settings or configured programs.

• Factory settings:

It is performed by long pressing (> 15s) the SET button. Green, red LED flashes 6 times

Factory settings - same state in which you received the time switch from production. Settings and all configured programs are cleared by this step.



Web Remote Control (WRC)

Allows you to set up and control the device via the Internet, without the need for a public IP address, which would otherwise be necessary. This function requires connecting the time switch to a local network with Internet access - see the section "Local network connection".

• Go to the "service" tab using the clickable menu

Activate the "Active" checkbox in the Web Remote Control item and click the "Change" button. Now copy the generated 8-digit key. Then continue to the URL address <https://wrc.elkoep.com>. Registration is required to log in - you will be able to do so at the link above. After creating an account, log in to it. After logging in, click the "+" icon at the bottom right. You will be prompted to enter the device name (according to your preferences) and the 8-digit key you copied. Then click the "Save" button. This will add the device and display it on the "Device" list. In the "Device" list you can find out the current status, change device name and more. If the device is active (connected to the power supply and has configured web remote control) the status icon will be green. In that case you can connect to it via the Internet using the icon . This way you can set up and control your device from anywhere via the Internet.



SHT-14 programming example

Setting the 1st channel to switch ON from sunset to sunrise with an offset (deviation) of -10 min for sunset and +20 min for sunrise with night break using astro interrupt from 22:00 to 5:00 every MONDAY - FRIDAY with a 15 min offset of astro interrupt for sunset/sunrise.

This configuration respects the sunrise and sunset times which in this particular example setup will not allow the contact to open/close if the sunset/sunrise time has not yet occurred, while the astro interrupt offset is also respected.

Setting the 1st channel to switch ON from sunset to sunrise with an offset (deviation) of -10 min for sunset and +20 min for sunrise with night break using time programs from 22:00 to 5:00 every MONDAY - FRIDAY.

This configuration does not respect the sunrise and sunset times, which can cause the contact to close even when it may no longer be desirable (e.g. after sunrise).



Type of load	 cos φ ≥ 0.95 AC1	AC2	AC3	AC5a uncompensated	AC5a compensated	HAL 230V AC5b	AC6a	AC7b	AC12
Contact material AgSnO ₂ , 16A	250V / 16A	250V / 5A	250V / 3A	230V / 3A (690VA)	230V / 3A (690VA) to max. input C=14uF	1000W	x	250V / 3A	x
Type of load	AC13	AC14	AC15	DC1	DC3	DCS	DC12	DC13	DC14
Contact material AgSnO ₂ , 16A	x	250V / 6A	250V / 6A	24V / 16A	24V / 3A	24V / 2A	24V / 16A	24V / 2A	x

* Note: Missing QR codes will be continuously added.